

**Lecture notes
on the Stefan problem**

Daniele Andreucci

Dipartimento di Metodi e Modelli Matematici

Università di Roma La Sapienza

via Antonio Scarpa 16 00161 Roma, Italy

`andreucci@dmmm.uniroma1.it`

Introduction

These notes cover a portion of a course of the Doctorate *Modelli e metodi matematici per la tecnologia e la società*, given in 2001 in Rome. The title of the course was ‘Evolution equations and free boundary problems’ and its topics included, essentially, an introduction to Stefan and Hele-Shaw problems.

Here only the material concerning the Stefan problem is partially reproduced.

The present notes assume the reader has some knowledge of the elementary theory of L^p and Sobolev spaces, as well as of the basic results of existence and regularity of solutions to smooth parabolic equations.

The bibliography is minimal; only books and articles quoted in the text are referenced. See [12], [18] and [20] for further references.

I thank the audience of the course for many stimulating comments and questions, and prof. R. Ricci for interesting discussions on the subject of these notes.

Rome, January 2002

Revised version: Rome, January 2004

Notation

The notation employed here is essentially standard.
Appendix D contains a list of the main symbols used in the text.
Constants denoted by γ , C , C_δ , \dots may change from line to line.

Contents

Introduction	iii
Notation	v
Chapter 1. The classical formulation	1
1. The Stefan condition	1
2. The free boundary problem	4
3. Explicit examples of solutions	5
4. Basic estimates	7
5. Existence and uniqueness of the solution	8
6. Qualitative behaviour of the solution	12
7. Regularity of the free boundary	15
Chapter 2. Weak formulation of the Stefan problem	19
1. From the energy balance to the weak formulation	19
2. Comparing the weak and the classical formulations	20
3. Definition of weak solution	24
4. Uniqueness of the weak solution	25
5. Existence of weak solutions	29
6. A comparison result	37
Appendix A. Maximum principles for parabolic equations	39
1. The weak maximum principle	39
2. The strong maximum principle	41
3. Hopf's lemma (the boundary point principle)	45
4. Maximum principle for weak solutions	48
Appendix B. A theorem by Kruzhkov	51
1. Mollifying kernels	51
2. The main estimate	53
Appendix C. The spaces $H^{m+\alpha, \frac{m+\alpha}{2}}(\overline{Q_T})$	55
1. Comments	55
Appendix D. Symbols used in text	57
Bibliography	59

CHAPTER 1

The classical formulation

In this chapter we consider the formulation of the Stefan problem as a classical initial boundary value problem for a parabolic partial differential equation. A portion of the boundary of the domain is a priori unknown (the *free boundary*), and therefore two boundary conditions must be prescribed on it, instead than only one, to obtain a well posed problem.

1. The Stefan condition

The Stefan problem ([17]) is probably the simplest mathematical model of a phenomenon of change of phase. When a change of phase takes place, a *latent heat* is either absorbed or released, while the temperature of the material changing its phase remains constant. In the following we denote by $L > 0$ the latent heat per unit of volume (p.u.v.), and neglect for the sake of simplicity any volume change in the material undergoing the change of phase. We also assume the critical temperature of change of phase to be a constant, θ_0 .

To be specific, consider at time $t = t_0$ a domain A divided by the plane $x_1 = s_0$ into two subdomains. At time $t = t_0$ the sub-domain $A_1 = A \cap \{x_1 < s_0\}$ is filled by water, while $A_2 = A \cap \{x_1 > s_0\}$ is filled by ice. In the terminology of problems of change of phase, A_1 is the *liquid phase* and A_2 is the *solid phase*. The surface separating the two phases is referred to as the *interface*. Assume also the setting is plane symmetric, that is the temperature θ is a function of x_1 only, besides the time t , and the interface is a plane at all times. Denote by $x_1 = s(t)$ the position of the interface at time t . Note that, due to the natural assumption that temperature is continuous,

$$\theta(s(t)+, t) = \theta(s(t)-, t) = \theta_0, \quad \text{for all } t. \quad (1.1)$$

Assume ice is changing its phase, that is the interface is advancing into the solid phase. Due to the symmetry assumption we stipulate, we may confine ourselves to consider any portion D , say a disk, of the interface at time t_0 . At a later time $t_1 > t_0$ the interface occupies a position $s(t_1) > s(t_0) = s_0$. The cylinder $D \times (s(t_1), s(t_0))$ has been melted over the time interval (t_0, t_1) (see Figure 1). The change of phase has therefore absorbed a quantity of heat

$$\text{volume of the melted cylinder} \times \text{latent heat p.u.v.} = \text{area}(D)(s(t_1) - s(t_0))L. \quad (1.2)$$

The heat must be provided by diffusion, as we assume that no heat source or sink is present. We adopt for heat diffusion Fourier's law

$$\text{heat flux} = -k_i D\theta, \quad (1.3)$$

where $k_1 > 0$ is the diffusivity coefficient in water, and $k_2 > 0$ is the diffusivity coefficient in ice (in principle $k_1 \neq k_2$). Thus, the quantity of heat in (1.2) must

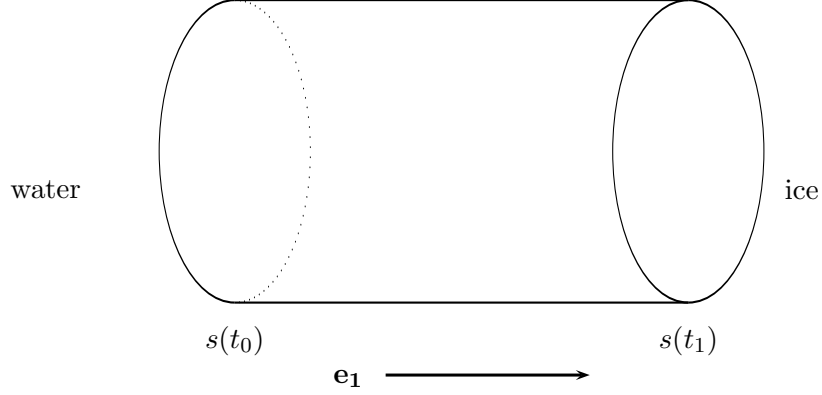

FIGURE 1. Melting ice

equal

$$\int_{t_0}^{t_1} \int_{D(t)} [-k_1 D\theta(s(t)-, t) \cdot \mathbf{e}_1 - k_2 D\theta(s(t)+, t) \cdot (-\mathbf{e}_1)] dx_2 dx_3 dt =$$

$$\text{area}(D) \int_{t_0}^{t_1} [-k_1 \theta_{x_1}(s(t)-, t) + k_2 \theta_{x_1}(s(t)+, t)] dt. \quad (1.4)$$

Equating the two quantities, dividing the equation by $t_1 - t_0$ and letting $t_1 \rightarrow t_0$, we finally find

$$-k_1 \theta_{x_1}(s(t)-, t) + k_2 \theta_{x_1}(s(t)+, t) = L\dot{s}(t), \quad (1.5)$$

where we have substituted t_0 with the general time t , as the same procedure can be obviously carried out at any time. This is called the *Stefan condition* on the free boundary. We stress the fact that the Stefan condition is merely a law of energetical balance.

Several remarks are in order.

REMARK 1.1. Note that, although we did not assume anything on the values of $\theta(x_1, t)$ *inside* each one of the two phases, on physical grounds we should expect

$$\theta \geq \theta_0, \quad \text{in water, i.e., in } A_1; \quad \theta \leq \theta_0, \quad \text{in ice, i.e., in } A_2. \quad (1.6)$$

The equality $\theta \equiv \theta_0$ in either one of the two phases (or in both) can not be ruled out in the model. Rather, it corresponds to the case when a whole phase is at critical temperature. Diffusion of heat, according to (1.3), can not take place in that phase, as $\theta_{x_1} \equiv 0$ there. Thus (1.5) reduces to, e.g., if the solid phase is at constant temperature,

$$-k_1 \theta_{x_1}(s(t)-, t) = L\dot{s}(t). \quad (1.7)$$

Note that if $\theta > \theta_0$ in water, (1.7) predicts that $\dot{s}(t) > 0$. In other words, melting of ice is predicted by the model, instead of solidification of water. This is consistent with obvious physical considerations.

Problems where one of the two phases is everywhere at the critical temperature

are usually referred to (somehow misleadingly) as *one phase problems*, while the general case where (1.5) is prescribed is the *two phases problem*. In the latter case, the sign of $\dot{s}(t)$, and therefore the physical behaviour of the system water/ice predicted by the mathematical model, depends on the relative magnitude of the two heat fluxes at the interface.

REMARK 1.2. On the interface, which is also known as the *free boundary* two conditions are therefore prescribed: (1.1) and (1.5).

In the case of a one phase problem, this fact has the following meaningful interpretation in terms of the general theory of parabolic PDE: The boundary of the domain where the heat equation (a parabolic equation based on (1.3)) is posed, contains an a priori unknown portion, corresponding to the interface separating the liquid phase from the solid one. Clearly, if only the Dirichlet boundary condition (1.1) was imposed on it, we could choose *arbitrarily* this part of the boundary, and solve the corresponding initial value boundary problem. Apparently the solution would not, in general, satisfy (1.7). A similar remark applies to solutions found imposing just (1.7) (where now the functional form of the arbitrarily given boundary $x_1 = s(t)$ is explicitly taken into account).

It is therefore evident that on the free boundary both conditions (1.1) and (1.7) should be prescribed in order to have a well posed problem. (Or, anyway, in more general free boundary problems, two different boundary conditions are required.) Incidentally, this circle of ideas provides the basic ingredient of a possible proof of the existence of solutions: we assign arbitrarily a ‘candidate’ free boundary s^* and consider the solution θ to the problem, say, corresponding to the data (1.1). Then we define a *transformed* boundary s^{**} exploiting (1.7), i.e.,

$$-k_1\theta_{x_1}(s^*(t)-, t) = L\dot{s}^{**}(t).$$

A fixed point of this transform corresponds to a solution of the complete problem.

REMARK 1.3. The meaning of conditions (1.1) and (1.5) in the context of two phases problems is probably better understood in terms of the *weak formulation* of the Stefan problem, which is discussed below in Chapter 2. We remark here that, actually, one phase problems are just two phases problems with one phase at constant temperature, so that the discussion in Chapter 2 applies to them too.

REMARK 1.4. Problems where the temperature restriction (1.6) is not fulfilled, are sometimes called *undercooled* Stefan problems. We do not treat them here, albeit their mathematical and physical interest (see however Subsection 2.4 of Chapter 2); let us only recall that they are, in some sense, ill posed.

1.1. Exercises.

1.1. Write the analogs of Stefan condition (1.5) in the cases of cylindrical and spherical symmetry in \mathbf{R}^3 .

1.2. Note that if we assume, in (1.5), $\theta < \theta_0$ in A_1 and $\theta \equiv \theta_0$ in A_2 , we find $\dot{s}(t) < 0$. This appears to be inconsistent with physical intuition: a phase of ice at sub critical temperature should *grow* into a phase of water at identically critical temperature. Indeed, (1.5) is not a suitable model for the physical setting considered here. In other words, the Stefan condition in the form given above keeps memory of which side of the interface is occupied by which phase. Find out where we implicitly took into account this piece of information and write the Stefan condition when ice and water switch places.

1.3. Prove that Stefan condition (1.5) does not change its form if bounded volumetric heat sources are present (i.e., if the heat equation is not homogeneous).

2. The free boundary problem

Keeping the plane symmetry setting considered above, we may of course assume the problem is one dimensional. Denoting by x the space variable, the complete two phases problem can be written as

$$c_1\theta_t - k_1\theta_{xx} = 0, \quad \text{in } Q_1, \quad (2.1)$$

$$c_2\theta_t - k_2\theta_{xx} = 0, \quad \text{in } Q_2, \quad (2.2)$$

$$-k_1\theta_x(0, t) = h_1(t), \quad 0 < t < T, \quad (2.3)$$

$$-k_2\theta_x(d, t) = h_2(t), \quad 0 < t < T, \quad (2.4)$$

$$\theta(x, 0) = \Theta(x), \quad 0 < x < d, \quad (2.5)$$

$$-k_1\theta_x(s(t)-, t) + k_2\theta_x(s(t)+, t) = L\dot{s}(t), \quad 0 < t < T, \quad (2.6)$$

$$\theta(s(t)-, t) = \theta(s(t)+, t) = \theta_0, \quad 0 < t < T, \quad (2.7)$$

$$s(0) = b. \quad (2.8)$$

Here $0 < b < d, T$ and c_1, c_2, k_1, k_2 are given positive numbers. The c_i represent the thermal capacities in the two phases. The liquid phase occupies at the initial time $t = 0$ the interval $(0, b)$, while the solid phase occupies (b, d) . The problem is posed in the time interval $(0, T)$. Moreover we have set

$$Q_1 = \{(x, t) \mid 0 < x < s(t), 0 < t < T\},$$

$$Q_2 = \{(x, t) \mid s(t) < x < d, 0 < t < T\}.$$

We are assuming that $0 < s(t) < d$ for all $0 < t < T$. If the free boundary hits one of the two fixed boundaries $x = 0$ and $x = d$, say at time t^* , of course the formulation above should be changed. In practice, one of the two phases disappears at $t = t^*$. We leave to the reader the simple task of writing the mathematical model for $t > t^*$.

One could impose other types of boundary data, instead of (2.3), (2.4), e.g., Dirichlet data.

If we are to attach the physical meaning of a change of phase model to the problem above, the data must satisfy suitable conditions. At any rate

$$\Theta(x) \geq \theta_0, \quad 0 < x < b; \quad \Theta(x) \leq \theta_0, \quad b < x < d.$$

Essentially, we need $\theta \geq \theta_0$ in Q_1 and $\theta \leq \theta_0$ in Q_2 .

Actually, we will deal mainly with the one phase version of (2.1)–(2.8) where the solid phase is at constant temperature. Namely, after adimensionalization, we look at

$$u_t - u_{xx} = 0, \quad \text{in } Q_{s,T}, \quad (2.9)$$

$$-u_x(0, t) = h(t) > 0, \quad 0 < t < T, \quad (2.10)$$

$$u(x, 0) = u_0(x) \geq 0, \quad 0 < x < b, \quad (2.11)$$

$$-u_x(s(t), t) = \dot{s}(t), \quad 0 < t < T, \quad (2.12)$$

$$u(s(t), t) = 0, \quad 0 < t < T, \quad (2.13)$$

$$s(0) = b. \quad (2.14)$$

(We have kept the old names for all variables excepting the unknown u .) Here we denote for each positive function $s \in C([0, T])$, such $s(0) = b$,

$$Q_{s,T} = \{(x, t) \mid 0 < x < s(t), 0 < t < T\}.$$

We regard the rescaled temperature u as a function defined in $Q_{s,T}$. The solid phase therefore does not appear explicitly in the problem. As a matter of fact we assume it to be unbounded in the positive x direction (i.e., $d = +\infty$), so that no upper limit has to be imposed on the growth of the free boundary s . The sign restrictions in (2.10) and in (2.11) are imposed so that $u > 0$ in $Q_{s,T}$, see Proposition 4.1 below.

DEFINITION 2.1. A solution to problem (2.9)–(2.14) is a pair (u, s) with

$$\begin{aligned} s &\in C^1((0, T]) \cap C([0, T]), \quad s(0) = b, \quad s(t) > 0, \quad 0 \leq t \leq T; \\ u &\in C(\overline{Q_{s,T}}) \cap C^{2,1}(Q_{s,T}), \quad u_x \in C(\overline{Q_{s,T}} - \{t = 0\}), \end{aligned}$$

and such that (2.9)–(2.14) are satisfied in a classical pointwise sense.

We prove a theorem of existence and uniqueness of solutions to (2.9)–(2.14), under the assumptions

$$h \in C([0, T]), \quad h(t) > 0, \quad 0 \leq t \leq T; \quad (2.15)$$

$$u_0 \in C([0, b]), \quad 0 \leq u_0(x) \leq H(b - x), \quad 0 \leq x \leq b. \quad (2.16)$$

We also study some qualitative behaviour of the solution. The adimensionalization of the problem does not play a substantial role in the mathematical theory we develop here.

For further reading on the one-phase Stefan problem, we refer the reader to [5], [3]; we employ in this chapter the techniques found there, with some changes.

REMARK 2.1. The free boundary problem (2.9)–(2.14) is strongly non linear, in spite of the linearity of the PDE and of the boundary conditions there. Indeed, recall that the free boundary s itself is an unknown of the problem; its dependence on the data is not linear (as, e.g., the explicit examples of Section 3 show).

2.1. Exercises.

2.1. Prove that the change of variables

$$\theta \mapsto \alpha u + \theta_0, \quad x \mapsto \beta \xi, \quad t \mapsto \gamma \tau,$$

allows one to write the one phase problem in the adimensionalized form (2.9)–(2.14), for a suitable choice of the constants α , β , γ .

Also note that adimensionalizing the complete two phases problem similarly is in general impossible.

3. Explicit examples of solutions

EXAMPLE 1. An explicit solution of the heat equation (2.9) is given by

$$\begin{aligned} v(x, t) &= \operatorname{erf}\left(\frac{x}{2\sqrt{t}}\right) = \frac{2}{\sqrt{\pi}} \int_0^{x/2\sqrt{t}} e^{-z^2} dz, \quad x, t > 0, \\ v(x, 0) &= 1, \quad x > 0. \end{aligned}$$

Here erf denotes the well known ‘error function’. Fix $C > 0$ arbitrarily, and set, for a $\alpha > 0$ to be chosen presently,

$$u(x, t) = C \left\{ \operatorname{erf} \alpha - \operatorname{erf} \left(\frac{x}{2\sqrt{t}} \right) \right\}.$$

Define also $s(t) = 2\alpha\sqrt{t}$; note that $s(0) = 0$. Thus $u > 0$ in $Q_{s,T}$, and (2.9) as well as (2.13) are satisfied. By direct calculation

$$u_x(x, t) = -\frac{C}{\sqrt{\pi t}} e^{-\frac{x^2}{4t}}.$$

Hence,

$$u_x(s(t), t) = u_x(2\alpha\sqrt{t}, t) = -\frac{C}{\sqrt{\pi t}} e^{-\alpha^2} = -\dot{s}(t) = -\frac{\alpha}{\sqrt{t}},$$

if and only if

$$C = \sqrt{\pi} \alpha e^{\alpha^2}.$$

Note that on the fixed boundary $x = 0$ we may select either one of the conditions

$$u_x(0, t) = -\frac{C}{\sqrt{\pi t}}, \quad \text{or} \quad u(0, t) = C \operatorname{erf} \alpha.$$

We have proven that, when α is chosen as above,

$$u(x, t) = 2\alpha e^{\alpha^2} \int_{x/2\sqrt{t}}^{\alpha} e^{-z^2} dz \quad (3.1)$$

solves the problem sketched in Figure 2. Note however that u is not continuous at $(0, 0)$; the notion of solution in this connection should be suitably redefined.

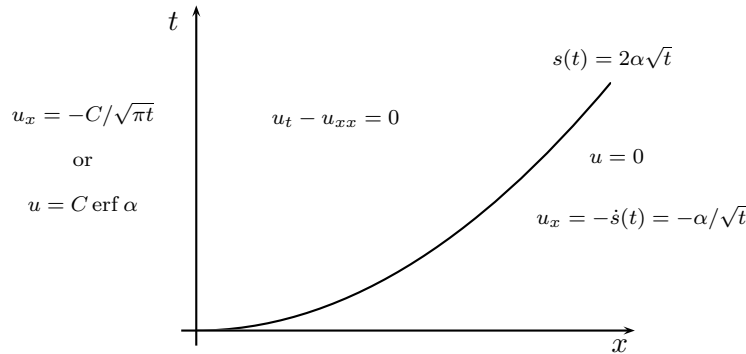
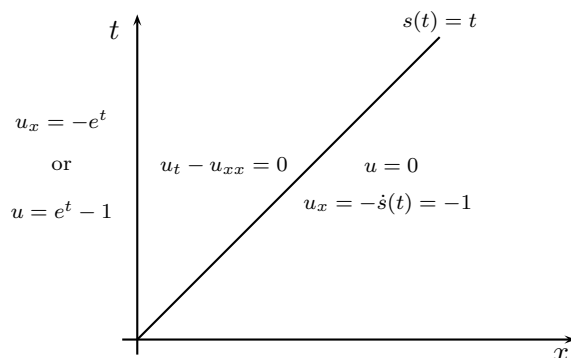

FIGURE 2. The Stefan problem solved by u in (3.1)

EXAMPLE 2. It is obvious by direct inspection that the function

$$u(x, t) = e^{t-x} - 1, \quad (3.2)$$

solves the Stefan problem in Figure 3, corresponding to the free boundary $s(t) = t$. Note that we are forced to prescribe an exponentially increasing flux on $x = 0$ in order to obtain a linear growth for $s(t)$.

FIGURE 3. The Stefan problem solved by u in (3.2)

3.1. Exercises.

3.1. Convince yourself that the solutions corresponding to $u_x(0, t) = -2C/\sqrt{\pi t}$, in the case of Example 1, and to $u_x(0, t) = -2e^t$ in the case of Example 2, can not be obtained by linearity from the ones given above.

4. Basic estimates

PROPOSITION 4.1. *If (u, s) is a solution to (2.9)–(2.14), then*

$$u(x, t) > 0, \quad \text{in } Q_{s,T}; \quad (4.1)$$

$$\dot{s}(t) > 0, \quad \text{for all } t > 0. \quad (4.2)$$

PROOF. By virtue of the weak maximum principle, u must attain its maximum on the parabolic boundary of $Q_{s,T}$, i.e., on

$$\partial Q_{s,T} - \{(x, t) \mid t = T, 0 < x < s(T)\}.$$

The data h being positive, the maximum is attained on $t = 0$ or on $x = s(t)$. Therefore $u \geq 0$ (remember that $u_0 \geq 0$). If we had $u(\bar{x}, \bar{t}) = 0$ in some $(\bar{x}, \bar{t}) \in Q_{s,T}$, invoking the strong maximum principle we would obtain $u \equiv 0$ in $Q_{s,T} \cap \{t < \bar{t}\}$. This is again inconsistent with $h > 0$. Thus (4.1) is proven.

Then, the value $u = 0$ attained on the free boundary is a minimum for u . Recalling the parabolic version of Hopf's lemma, we infer

$$\dot{s}(t) = -u_x(s(t), t) > 0, \quad \text{for all } t > 0.$$

□

REMARK 4.1. The proof of estimate (4.1) does not make use of the Stefan condition (2.12). In the same spirit, we consider in the following results solutions to the initial value boundary problem obtained removing Stefan condition from the formulation. The rationale for this approach is that we want to apply those results to 'approximating' solutions constructed according to the ideas of Remark 1.2.

LEMMA 4.1. *Let u be a solution of (2.9), (2.10), (2.11), (2.13), where s is assumed to be a positive non decreasing Lipschitz continuous function in $[0, T]$, such that $s(0) = b$. Let (2.15) and (2.16) be in force. Then u_x is continuous up to all the points of the boundary of $Q_{s,T}$ of the form $(0, t)$, $(s(t), t)$, with $T \geq t > 0$.*

The regularity of u_x up to $x = 0$ is classical; the proof of this result will be completed in Section 7, see Lemma 7.1.

PROPOSITION 4.2. *Let u, s be as in Lemma 4.1. Then*

$$0 < u(x, t) \leq M(s(t) - x), \quad \text{in } Q_{s, T}, \quad (4.3)$$

where $M = \max(\|h\|_\infty, H)$.

PROOF. Define $v(x, t) = M(s(t) - x)$. It follows immediately

$$\begin{aligned} v_t - v_{xx} &= M\dot{s}(t) \geq 0, & \text{in } Q_{s, T}; \\ v(s(t), t) &= u(s(t), t) = 0, & 0 \leq t \leq T, \\ v_x(0, t) &= -M \leq -h = u_x(0, t), & 0 < t < T, \\ v(x, 0) &= M(b - x) \geq u_0(x) = u(x, 0), & 0 \leq x \leq b. \end{aligned}$$

Therefore, taking into account the results of Appendix A,

$$v(x, t) \geq u(x, t), \quad \text{in } Q_{s, T}.$$

□

COROLLARY 4.1. *If u, s are as in Proposition 4.2, then*

$$0 > u_x(s(t), t) \geq -M, \quad 0 < t < T, \quad (4.4)$$

where M is the constant defined in Proposition 4.2.

PROOF. A trivial consequence of Proposition 4.1 and of Proposition 4.2, as well as of Lemma 4.1. We also keep in mind Remark 4.1, and of course make use of Hopf's lemma for the strict inequality in (4.4). □

REMARK 4.2. We stress the fact that the barrier construction of Proposition 4.2 is made possible by the fact that $\dot{s} \geq 0$. In turn, this is for solutions of the Stefan problem a consequence of the positivity of u . Thus, such a barrier function, and in general any similar barrier function, does not exist in the case of the undercooled Stefan problem.

4.1. Exercises.

4.1. Note that the function v defined in the proof of Proposition 4.2 is just Lipschitz continuous in t . In spite of this fact, one may apply to $v - u$ the weak maximum principle in the form given in Section 4 of Appendix A. Carry out the proof in detail.

5. Existence and uniqueness of the solution

We prove here

THEOREM 5.1. *Assume (2.15), (2.16). Then there exists a unique solution to (2.9)–(2.14).*

Let u, s be as in Proposition 4.2. Moreover assume that

$$s \in \Sigma := \{\sigma \in \text{Lip}([0, T]) \mid 0 \leq \dot{\sigma} \leq M, \sigma(0) = b\}.$$

Here M is the constant defined in Proposition 4.2. The set Σ is a convex compact subset of the Banach space $C([0, T])$, equipped with the max norm. A useful property of all $s \in \Sigma$ is

$$b + Mt \geq s(t) \geq b, \quad 0 \leq t \leq T.$$

Define the transform $\mathcal{T}(s)$ by

$$\mathcal{T}(s)(t) = b - \int_0^t u_x(s(\tau), \tau) \, d\tau, \quad T \geq t \geq 0.$$

Note that, as a consequence of Lemma 4.1 and of Corollary 4.1,

$$\mathcal{T}(s) \in \text{Lip}([0, T]) \cap C^1((0, T]),$$

and

$$M \geq \frac{d}{dt} \mathcal{T}(s)(t) = -u_x(s(t), t) \geq 0, \quad t > 0.$$

Then $\mathcal{T} : \Sigma \rightarrow \Sigma$. Also note that a fixed point of \mathcal{T} corresponds to a solution of our Stefan problem.

We use the divergence theorem to transform the boundary flux integral defining $\mathcal{T}(s)$. Namely we write

$$\begin{aligned} 0 &= \int_0^t \int_0^{s(\tau)} (u_\tau - u_{xx}) \, dx \, d\tau = - \int_0^b u_0(x) \, dx - \int_0^t u(s(\tau), \tau) \dot{s}(\tau) \, d\tau \\ &\quad + \int_0^{s(t)} u(x, t) \, dx - \int_0^t u_x(s(\tau), \tau) \, d\tau - \int_0^t h(\tau) \, d\tau. \end{aligned}$$

Therefore

$$\begin{aligned} \mathcal{T}(s)(t) &= b - \int_0^t u_x(s(\tau), \tau) \, d\tau = \\ &= b + \int_0^b u_0(x) \, dx + \int_0^t h(\tau) \, d\tau - \int_0^{s(t)} u(x, t) \, dx =: F(t) - \int_0^{s(t)} u(x, t) \, dx. \end{aligned} \quad (5.1)$$

Note that this equality allows us to express $\mathcal{T}(s)$ in terms of more regular functions than the flux $u_x(s(t), t)$, which appeared in its original definition. We are now in a position to prove that \mathcal{T} is continuous in the max norm.

Let $s_1, s_2 \in \Sigma$. Let us define

$$\begin{aligned} \alpha(t) &= \min(s_1(t), s_2(t)), & \beta(t) &= \max(s_1(t), s_2(t)), \\ i &= 1, & \text{if } \beta(t) &= s_1(t), & i &= 2, & \text{otherwise.} \end{aligned}$$

(The number i is a function of time; this will not have any specific relevance.)

Let us also define

$$v(x, t) = u_1(x, t) - u_2(x, t).$$

Then v satisfies

$$v_t - v_{xx} = 0, \quad \text{in } Q_{\alpha, T}, \quad (5.2)$$

$$v_x(0, t) = 0, \quad 0 < t < T, \quad (5.3)$$

$$v(x, 0) = 0, \quad 0 < x < b, \quad (5.4)$$

$$|v(\alpha(t), t)| = |u_i(\alpha(t), t)| \leq M(\beta(t) - \alpha(t)), \quad 0 < t < T. \quad (5.5)$$

Therefore, we may invoke the maximum principle to obtain

$$\|v\|_{\infty,t} := \max_{Q_{\alpha,t}} |v| \leq M \|s_1 - s_2\|_{\infty,t}, \quad (5.6)$$

where we also denote

$$\|s_1 - s_2\|_{\infty,t} = \max_{0 \leq \tau \leq t} |s_1(\tau) - s_2(\tau)|.$$

On the other hand, we have

$$\begin{aligned} \mathcal{T}(s_1)(t) - \mathcal{T}(s_2)(t) &= \int_0^{s_2(t)} u_2(x, t) \, dx - \int_0^{s_1(t)} u_1(x, t) \, dx \\ &= - \int_0^{\alpha(t)} v(x, t) \, dx + (-1)^i \int_{\alpha(t)}^{\beta(t)} u_i(x, t) \, dx. \end{aligned}$$

Therefore

$$\begin{aligned} |\mathcal{T}(s_1)(t) - \mathcal{T}(s_2)(t)| &\leq |\alpha(t)| \|v\|_{\infty,t} + M(\beta(t) - \alpha(t))^2 \\ &\leq (b + MT)M \|s_1 - s_2\|_{\infty,t} + M \|s_1 - s_2\|_{\infty,t}^2, \quad (5.7) \end{aligned}$$

and the continuity of $\mathcal{T} : \Sigma \rightarrow \Sigma$ is proven. By Schauder's theorem, it follows that a fixed point of \mathcal{T} exists, and thus existence of a solution. Uniqueness might be proven invoking the monotone dependence result given below (see Theorem 6.1).

However, mainly with the purpose of elucidating the role played in the theory of free boundary problems by local integral estimates, we proceed to give a direct proof of uniqueness of solutions. More explicitly, we prove the contractive character (for small t) of \mathcal{T} , thereby obtaining existence and uniqueness of a fixed point.

5.1. Local estimates vs the maximum principle. Estimates like (5.6), obtained through the maximum principle, have the advantage of providing an immediate sup estimate of the solution in the whole domain of definition. However, the bound they give may be too rough, at least in some regions of the domain. Consider for example, in the setting above, a point $(b/2, \varepsilon)$, with $\varepsilon \ll 1$. The maximum principle predicts for $v(b/2, \varepsilon)$ a bound of order $M \|s_1 - s_2\|_{\infty, \varepsilon}$, that is, obviously, the same bound satisfied by the boundary data for v . On the other hand, taking into account (5.3), (5.4) one might expect $v(b/2, \varepsilon)$ to be much smaller than $v(\alpha(\varepsilon), \varepsilon)$.

This is indeed the case, as we show below. In order to do so, we exploit local integral estimates of the solution, that is, estimates involving only values of v in the region of interest, in this case, away from the boundary. We aim at proving that \mathcal{T} is a contraction, that is,

$$\|\mathcal{T}(s_1) - \mathcal{T}(s_2)\|_{\infty,t} \leq d \|s_1 - s_2\|_{\infty,t}, \quad (5.8)$$

with $d < 1$ for small enough t . A quick glance at (5.7) shows that (5.8) does not, indeed, follow from there (unless $bM < 1$). This failure is due only to the term

originating from the estimate of

$$\int_0^{\alpha(t)} v(x, t) \, dx.$$

Thus, a better estimate of this integral is needed.

A key step in any local estimation is a good choice of cut off functions. These are, typically, non negative smooth functions equal to 1 in the region we want to single out, and identically vanishing away from it.

Let $b/2 > \delta > 0$, and define the cut off function $\zeta(x)$, such that

$$\zeta(x) = 1, \quad 0 \leq x \leq b - 2\delta, \quad \zeta(x) = 0, \quad b - \delta \leq x, \quad -\frac{2}{\delta} \leq \zeta_x(x) \leq 0.$$

Multiply (5.2) by $v\zeta^2$ and integrate by parts in $Q_{b,t} = [0, b] \times [0, t]$. We get

$$\begin{aligned} 0 &= \iint_{Q_{b,t}} (v_\tau v \zeta^2 - v_{xx} v \zeta^2) \, dx \, d\tau \\ &= \frac{1}{2} \int_0^b v(x, t)^2 \zeta(x)^2 \, dx + \iint_{Q_{b,t}} v_x^2 \zeta^2 \, dx \, d\tau + 2 \iint_{Q_{b,t}} v v_x \zeta \zeta_x \, dx \, d\tau, \end{aligned} \quad (5.9)$$

whence (using the inequality $2ab \leq \varepsilon a^2 + b^2/\varepsilon$, $\varepsilon > 0$)

$$\begin{aligned} \frac{1}{2} \int_0^b v(x, t)^2 \zeta(x)^2 \, dx + \iint_{Q_{b,t}} v_x^2 \zeta^2 \, dx \, d\tau &\leq 2 \iint_{Q_{b,t}} |v_x| |v| |\zeta_x| \zeta \, dx \, d\tau \\ &\leq 2 \iint_{Q_{b,t}} v^2 \zeta_x^2 \, dx \, d\tau + \frac{1}{2} \iint_{Q_{b,t}} v_x^2 \zeta^2 \, dx \, d\tau. \end{aligned}$$

By absorbing the last integral into the left hand side, we find

$$\begin{aligned} \int_0^b v(x, t)^2 \zeta(x)^2 \, dx + \iint_{Q_{b,t}} v_x^2 \zeta^2 \, dx \, d\tau &\leq 4 \iint_{Q_{b,t}} v^2 \zeta_x^2 \, dx \, d\tau \\ &= 4 \int_0^t \int_{b-2\delta}^{b-\delta} v^2 \zeta_x^2 \, dx \, d\tau \leq \frac{16}{\delta^2} t \delta \|v\|_{\infty, t}^2 = \frac{16}{\delta} t \|v\|_{\infty, t}^2. \end{aligned} \quad (5.10)$$

Let us now go back to

$$\begin{aligned} \mathcal{T}(s_1)(t) - \mathcal{T}(s_2)(t) &= - \int_0^{\alpha(t)} v(x, t) \, dx + (-1)^i \int_{\alpha(t)}^{\beta(t)} u_i(x, t) \, dx \\ &= \int_0^{b-2\delta} v(x, t) \, dx + \int_{b-2\delta}^{\alpha(t)} v(x, t) \, dx + (-1)^i \int_{\alpha(t)}^{\beta(t)} u_i(x, t) \, dx. \end{aligned}$$

Use Hölder's inequality and (5.10) to bound the integral over $(0, b - 2\delta)$ (recall that $\zeta \equiv 1$ there), and find

$$\begin{aligned} |\mathcal{T}(s_1)(t) - \mathcal{T}(s_2)(t)| &\leq \left(\int_0^{b-2\delta} v(x, t)^2 dx \right)^{1/2} \sqrt{b} + (\alpha(t) - b + 2\delta) \|v\|_{\infty, t} \\ &+ M(\beta(t) - \alpha(t))^2 \leq \sqrt{b} \frac{4}{\sqrt{\delta}} \sqrt{t} \|v\|_{\infty, t} + (Mt + 2\delta) \|v\|_{\infty, t} + M(\beta(t) - \alpha(t))^2. \end{aligned}$$

Take now $\delta = \sqrt{t}$ (t is fixed in this argument), and apply again the sup estimate (5.6), finally obtaining

$$\|\mathcal{T}(s_1) - \mathcal{T}(s_2)\|_{\infty, t} \leq \{4M\sqrt{b}\sqrt[4]{t} + M(Mt + 2\sqrt{t}) + M^2t\} \|s_1 - s_2\|_{\infty, t}.$$

Clearly, for $t = t_0(M, b)$, \mathcal{T} is a contractive mapping.

5.2. Exercises.

5.1. In Subsection 5.1 we proved existence and uniqueness of a fixed point of \mathcal{T} in a small time interval (*locally in time*). Show how the argument can be completed to give existence and uniqueness of a fixed point in any time interval (*global existence*).

5.2. Why uniqueness of solutions (u, s) with $s \in \Sigma$ is equivalent to uniqueness of solutions in the class of Definition 2.1, without further restrictions?

5.3. Give an interpretation of (5.1) as an energetical balance.

5.4. Prove that \mathcal{T} has the property (see also Figure 4)

$$s_1(t) < s_2(t), \quad 0 < t < T \quad \implies \quad \mathcal{T}(s_1)(t) > \mathcal{T}(s_2)(t), \quad 0 < t < T.$$

5.5. Extend the proof of existence and uniqueness of solutions to the case when $h \geq 0$. What happens if $h \equiv 0$, $u_0 \equiv 0$?

5.6. To carry out rigorously the calculations in (5.9) actually we need an approximation procedure: i.e., we need first perform integration in a smaller 2-dimensional domain, bounded away from the boundaries $x = 0$, $t = 0$. Recognize the need of this approach, and go over the (easy) details.

6. Qualitative behaviour of the solution

THEOREM 6.1. (MONOTONE DEPENDENCE) *Let (u_i, s_i) be solutions of (2.9)–(2.14), $i = 1, 2$, respectively corresponding to data $h = h_i$, $b = b_i$, $u_0 = u_{0i}$. Assume both sets of data satisfy (2.15), (2.16). If*

$$h_1(t) \leq h_2(t), \quad 0 < t < T; \quad b_1 \leq b_2; \quad u_{01}(x) \leq u_{02}(x), \quad 0 < x < b_1; \quad (6.1)$$

then

$$s_1(t) \leq s_2(t), \quad 0 < t < T. \quad (6.2)$$

PROOF. 1) Let us assume first $b_1 < b_2$. Reasoning by contradiction, assume

$$\bar{t} = \inf\{t \mid s_1(t) = s_2(t)\} \in (0, T).$$

Then the function $v = u_2 - u_1$ is strictly positive in

$$\{0 < t < \bar{t}, 0 < x < s_1(t)\},$$

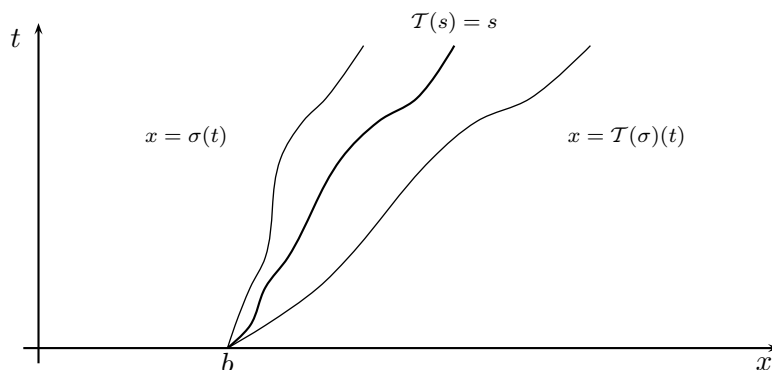
FIGURE 4. Behaviour of the transform \mathcal{T}

by virtue of the strong maximum principle and Hopf's lemma. Indeed,

$$v(s_1(t), t) > 0, \quad 0 < t < \bar{t}.$$

Then v attains a minimum at $(s_1(\bar{t}), \bar{t}) = (s_2(\bar{t}), \bar{t})$, where

$$v(s_1(\bar{t}), \bar{t}) = 0.$$

Thus, due to Hopf's lemma,

$$v_x(s_1(\bar{t}), \bar{t}) < 0.$$

But we compute

$$v_x(s_1(\bar{t}), \bar{t}) = u_{2x}(s_2(\bar{t}), \bar{t}) - u_{1x}(s_1(\bar{t}), \bar{t}) = -\dot{s}_2(\bar{t}) + \dot{s}_1(\bar{t}).$$

Hence $\dot{s}_2(\bar{t}) > \dot{s}_1(\bar{t})$, which is not consistent with the definition of \bar{t} .

2) Assume now $b_1 = b_2$. Let us extend the data u_{02} to zero over $(b, b + \delta)$, where $0 < \delta < 1$ is arbitrary. Let (u_δ, s_δ) be the solution of problem (2.9)–(2.14) corresponding to the data $h = h_2$, $b = b_2 + \delta$, $u_0 = u_{02}$. Then, by the first part of the proof, $s_2 < s_\delta$, $s_1 < s_\delta$, and for all $0 < t < T$

$$s_\delta(t) - s_2(t) = \delta - \int_0^{s_2(t)} [u_\delta - u_2](x, t) dx - \int_{s_2(t)}^{s_\delta(t)} u_\delta(x, t) dx \leq \delta.$$

Therefore $s_\delta \leq s_2 + \delta$, so that $s_1 < s_\delta \leq s_2 + \delta$. On letting $\delta \rightarrow 0$ we recover $s_1 \leq s_2$. \square

Let us investigate the behaviour of the solution of the Stefan problem for large times. In doing so, we of course assume that $T = \infty$. Note that the result of existence and uniqueness applies over each finite time interval; a standard extension technique allows us to prove existence and uniqueness of a solution defined for all positive times.

Owing to Proposition 4.2, we have

$$s(t) \leq S, \quad 0 < t < \infty \quad \implies \quad u(x, t) \leq MS, \quad \text{in } Q_{s, \infty}. \quad (6.3)$$

Moreover, s being monotonic, certainly there exists

$$s_\infty = \lim_{t \rightarrow \infty} s(t). \quad (6.4)$$

THEOREM 6.2. *Let (u, s) be the solution of Theorem 5.1. Then*

$$s_\infty = \lim_{t \rightarrow \infty} s(t) = b + \int_0^b u_0(x) dx + \int_0^\infty h(t) dt. \quad (6.5)$$

PROOF. 1) Assume first

$$\int_0^\infty h(t) dt = +\infty. \quad (6.6)$$

We only need show s is unbounded. Let us recall that, for all $t > 0$,

$$s(t) = b + \int_0^b u_0(x) dx + \int_0^t h(\tau) d\tau - \int_0^{s(t)} u(x, t) dx. \quad (6.7)$$

From (6.3), it follows that, if s is bounded over $(0, \infty)$, then u is also bounded over $(0, \infty)$. This is clearly inconsistent with (6.7), when we keep in mind (6.6).

2) Assume

$$\int_0^\infty h(t) dt < +\infty. \quad (6.8)$$

The balance law (6.7), together with $u > 0$, immediately yields

$$s(t) < b + \int_0^b u_0(x) dx + \int_0^\infty h(t) dt < +\infty. \quad (6.9)$$

Then we have $s(t) \rightarrow s_\infty < \infty$; it is only left to identify s_∞ as the quantity indicated above. Owing to (6.7) again, we only need show

$$\lim_{t \rightarrow \infty} \int_0^{s(t)} u(x, t) dx = 0. \quad (6.10)$$

On multiplying (2.9) by u and integrating by parts in $Q_{s,t}$, we get

$$\frac{1}{2} \int_0^{s(t)} u(x, t)^2 dx + \iint_{Q_{s,t}} u_x^2 dx d\tau = \frac{1}{2} \int_0^b u_0(x)^2 dx + \int_0^t u(0, \tau) h(\tau) d\tau. \quad (6.11)$$

Recalling (6.3) and (6.9), the last integral in (6.11) is majorised by

$$\int_0^\infty M s_\infty h(\tau) d\tau < \infty.$$

Thus a consequence of (6.11) is

$$\iint_{Q_{s,\infty}} u_x(x, t)^2 dx dt < +\infty. \quad (6.12)$$

Elementary calculus then shows that

$$\begin{aligned} \iint_{Q_{s,\infty}} u(x,t)^2 dx dt &= \iint_{Q_{s,\infty}} \left[\int_x^{s(t)} u_\xi(\xi,t) d\xi \right]^2 dx dt \\ &\leq s_\infty \iint_{Q_{s,\infty}} \int_x^{s(t)} u_\xi(\xi,t)^2 d\xi dx dt \leq s_\infty^2 \iint_{Q_{s,\infty}} u_\xi(\xi,t)^2 d\xi dt < \infty. \end{aligned}$$

Then there exists a sequence $\{t_n\}$, $t_n \rightarrow \infty$, such that

$$\int_0^{s(t_n)} u(x,t_n)^2 dx \rightarrow 0.$$

But the function

$$t \mapsto \int_0^{s(t)} u(x,t)^2 dx,$$

when we take into account (6.11), is easily seen to have limit as $t \rightarrow \infty$, so that this limit is 0. By Hölder's inequality,

$$\int_0^{s(t)} u(x,t) dx \leq \sqrt{s_\infty} \left[\int_0^{s(t)} u(x,t)^2 dx \right]^{1/2} \rightarrow 0, \quad t \rightarrow \infty,$$

completing the proof of (6.10). \square

6.1. Exercises.

6.1. Find conditions ensuring that the inequality in (6.2) is strict.

6.2. Discuss the necessity of assumptions (2.15), (2.16) in Theorem 6.1.

7. Regularity of the free boundary

The approach in this Section is taken from [16], and provides an example of 'bootstrap' argument, i.e., of an inductive proof where any given smoothness of the solution allows us to prove even more regularity for it. Our first result will become the first step in the induction procedure, and is however required to prove Lemma 4.1.

LEMMA 7.1. *Let $u \in C^{2,1}(Q_{s,T}) \cap C(\overline{Q_{s,T}})$, where $s \in \text{Lip}([0,T])$, and $s(t) > 0$ for $0 \leq t \leq T$. Assume u fulfils*

$$u_t - u_{xx} = 0, \quad \text{in } Q_{s,T}, \quad (7.1)$$

$$u(s(t), t) = 0, \quad 0 \leq t \leq T. \quad (7.2)$$

Then for each small enough $\varepsilon > 0$, u_x is continuous in $\overline{P_\varepsilon}$, where $P_\varepsilon = \{(x,t) \mid \varepsilon < x < s(t), \varepsilon < t < T\}$.

PROOF. The proof is based on standard local regularity estimates for solutions of parabolic equations. Introduce the following change of variables

$$\begin{cases} y = \frac{x}{s(t)}, \\ \tau = t; \end{cases} \quad v(y, \tau) = u(ys(\tau), \tau).$$

The set $Q_{s,T}$ is mapped onto $R = (0, 1) \times (0, T)$, where v solves

$$v_\tau - \frac{1}{s(\tau)^2} v_{yy} - \frac{\dot{s}(\tau)}{s(\tau)} y v_y = 0, \quad \text{in } R, \quad (7.3)$$

$$v(1, \tau) = 0, \quad 0 \leq \tau \leq T. \quad (7.4)$$

More explicitly, (7.3) is solved a.e. in R , as v is locally a Sobolev function in R . Classical results, see [11] Chapter IV, Section 10, imply that for any fixed $\varepsilon > 0$,

$$v_\tau, v_y, v_{yy} \in L^q((\varepsilon, 1) \times (\varepsilon, T)),$$

for all $q > 1$. Then we use the embedding Lemma 3.3 of [11] Chapter II, to infer that, for $q > 3$,

$$v_y \in H^{\alpha, \frac{\alpha}{2}}([\varepsilon, 1] \times [\varepsilon, T]), \quad (7.5)$$

where $\alpha = 1 - 3/q$ (see also Remark 11.2 of [11], p. 218; the space $H^{\alpha, \frac{\alpha}{2}}$ is defined in Appendix C). Since

$$u_x(x, t) = \frac{1}{s(t)} v_y\left(\frac{x}{s(t)}, t\right),$$

the result follows. \square

Our next result implies that the free boundary in the Stefan problem (2.9)–(2.14) is of class $C^\infty(0, T)$.

THEOREM 7.1. *Assume u and s are as in Lemma 7.1, and moreover*

$$u_x(s(t), t) = cs(t), \quad 0 < t < T, \quad (7.6)$$

where $c \neq 0$ is a given constant. Then $s \in C^\infty(0, T)$.

PROOF. For v defined as in the proof of Lemma 7.1, we rewrite (7.6) as

$$\dot{s}(\tau) = \frac{1}{cs(\tau)} v_y(1, \tau), \quad 0 < \tau < T. \quad (7.7)$$

Choose $\alpha \in (0, 1)$. Then (7.5) and (7.7) yield at once

$$\dot{s} \in H^{\alpha, \frac{\alpha}{2}}([\varepsilon, 1] \times [\varepsilon, T]), \quad \text{for each fixed } \varepsilon > 0. \quad (7.8)$$

Next we make use of the following classical result:

$$\begin{aligned} &\text{If the coefficients in (7.3) (i.e., } \dot{s}), \text{ are of class} \\ &H^{m+\alpha, \frac{m+\alpha}{2}}([\varepsilon, 1] \times [\varepsilon, T]), \text{ then } v \text{ is of class} \\ &H^{2+m+\alpha, \frac{2+m+\alpha}{2}}([2\varepsilon, 1] \times [2\varepsilon, T]). \end{aligned} \quad (7.9)$$

Here $m \geq 0$ is any integer. We prove by induction that for all $m \geq 0$

$$\dot{s} \in H^{m+\alpha, \frac{m+\alpha}{2}}([\varepsilon, 1] \times [\varepsilon, T]), \quad \text{for each fixed } \varepsilon > 0. \quad (7.10)$$

We already know this is the case when $m = 0$, from (7.8). Assume then (7.10) is in force for a given $m \geq 0$. Then, owing to (7.9),

$$v \in H^{2+m+\alpha, \frac{2+m+\alpha}{2}}([\varepsilon, 1] \times [\varepsilon, T]), \quad \text{for each fixed } \varepsilon > 0. \quad (7.11)$$

Therefore, by the definition of the spaces $H^{\lambda, \frac{\lambda}{2}}$ (see Appendix C), we have that

$$v_y \in H^{1+m+\alpha, \frac{1+m+\alpha}{2}}([\varepsilon, 1] \times [\varepsilon, T]), \quad \text{for each fixed } \varepsilon > 0. \quad (7.12)$$

Thus, taking (7.7) into account,

$$\dot{s} \in H^{1+m+\alpha, \frac{1+m+\alpha}{2}}([\varepsilon, 1] \times [\varepsilon, T]), \quad \text{for each fixed } \varepsilon > 0 \quad (7.13)$$

(we have used also (1.1) of Appendix C). The induction step, and the proof, are completed. \square

CHAPTER 2

Weak formulation of the Stefan problem

In this chapter we consider the weak formulation of the Stefan problem. As in other PDE problems, the weak formulation actually takes the form of an integral equality. It is to be noted that any *explicit* reference to the free boundary is dropped from the weak formulation.

We'll comment on the modeling differences between the classical and the weak formulations, and give the basic mathematical results for the latter.

We work in the multi-dimensional case of a spatial domain $\Omega \subset \mathbf{R}^N$. We still denote the temperature by u in this chapter.

1. From the energy balance to the weak formulation

The heat equation

$$u_t = \operatorname{div}(Du) + f, \tag{1.1}$$

amounts to an energy balance equating the local change in time of ‘energy’ (expressed by u_t ; various physical constants are normalized to 1 here), to the divergence of the ‘energy flux’, plus the contribution of volumetric sources, represented by f .

The weak formulation is based on the extension of this idea to the case where the energy exhibits a jump at the critical temperature, due to the change of phase, as shown in Figure 1. Then we write (formally)

$$\frac{\partial}{\partial t} v = \operatorname{div}(Du) + f, \tag{1.2}$$

where the ‘energy’ (more exactly, the *enthalpy*) v jumps at the change of phase.

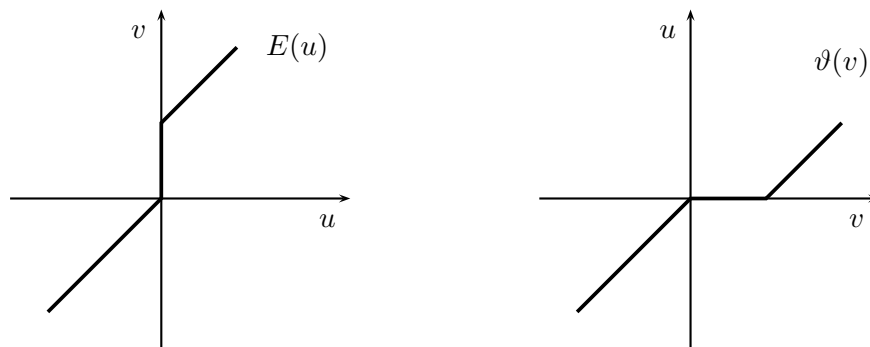

FIGURE 1. Enthalpy v as a graph of temperature u , and viceversa.

Specifically, solid at the critical temperature $u = 0$ corresponds to $v = 0$, while liquid at temperature $u = 0$ corresponds to $v = 1$ (we assume the latent heat

is normalized to unity). Where $0 < v < 1$, therefore, change of phase is taking place, and the corresponding region is filled with a material whose state is neither pure solid nor pure liquid. Such regions are usually called *mushy regions*.

The standard heat equation is assumed to hold in the pure phases (i.e., where $v > 1$ or $v < 0$). This essentially amounts to

$$v = \begin{cases} u, & u < 0, \\ u + 1, & u > 0. \end{cases} \quad (1.3)$$

Where $0 < v < 1$, u must equal the critical temperature $u = 0$. It is therefore convenient to express the relation between v and u as follows

$$u(x, t) = \begin{cases} v(x, t), & v(x, t) \leq 0, \\ 0, & 0 < v(x, t) < 1, \\ v(x, t) - 1, & v(x, t) \geq 1. \end{cases} \quad (1.4)$$

Note that v (not u) carries all the information on the state of the material. We can rephrase (1.4) in the language of graphs:

$$v \in E(u), \quad (1.5)$$

where E is the graph defined by

$$E(s) = \begin{cases} s, & s < 0, \\ [0, 1], & s = 0, \\ s + 1, & s > 0. \end{cases} \quad (1.6)$$

When v, u satisfy (1.5), we say that v is an *admissible enthalpy* for u , or that u is an *admissible temperature* for v .

Obviously, (1.2) can not be given a classical pointwise interpretation, since v is general not continuous (see (1.5)). Following an usual procedure, we obtain the *weak formulation* of (1.2) on multiplying both sides of it by a *testing function* $\varphi \in C_0^\infty(Q_T)$, and integrating (formally) by parts. In this way some of the derivatives appearing in (1.2) are unloaded on the smooth testing function. We obtain

$$\iint_{Q_T} \{-v\varphi_t + Du \cdot D\varphi\} dx dt = \iint_{Q_T} f\varphi dx dt. \quad (1.7)$$

Note that this formulation requires only we give a meaning to the first spatial derivatives of u (for example, u may be a Sobolev function). The complete formulation of the Stefan problem will be given below (see Section 3).

The notion of weak solutions to the Stefan problem was introduced in [14], [9].

2. Comparing the weak and the classical formulations

2.1. The spatial normal. Let S be a smooth surface of \mathbf{R}^{N+1} , which we may assume for our purposes to be locally represented in the form

$$\Phi(x, t) = 0, \quad (2.1)$$

with $\Phi \in C^1(\mathbf{R}^{N+1})$, and $D\Phi \neq 0$ everywhere. Here we denote by $D\Phi$ the gradient of Φ with respect to x , and by $\nabla\Phi = (D\Phi, \Phi_t)$ the complete gradient of Φ with respect to (x, t) .

We may think of S as of a moving surface in \mathbf{R}^N . More exactly, at each fixed instant t the surface takes the position

$$S(t) = \{x \in \mathbf{R}^N \mid \Phi(x, t) = 0\}.$$

A moving point $x(t)$ belongs to $S(t)$ for all t if and only if

$$\Phi(x(t), t) = 0, \quad \text{for all } t,$$

which is equivalent, up to the choice of suitable initial data, to

$$D\Phi(x(t), t) \cdot \dot{x}(t) + \Phi_t(x(t), t) = 0, \quad \text{for all } t.$$

Define the *spatial normal* on S by

$$\mathbf{n} = \frac{D\Phi(x(t), t)}{|D\Phi(x(t), t)|}. \quad (2.2)$$

The spatial normal, of course, is defined up to a change in sign. We have for all motions $t \mapsto x(t)$ as above

$$\dot{x}(t) \cdot \mathbf{n} = -\frac{\Phi_t(x(t), t)}{|D\Phi(x(t), t)|}.$$

This shows that, at a given position on S , the component of the velocity \dot{x} along the spatial normal is independent of the motion x . This quantity is referred to as the *normal velocity* V of S . Therefore, we have by definition

$$V(x, t) = -\frac{\Phi_t(x(t), t)}{|D\Phi(x(t), t)|}.$$

Again, note that V is defined up to a change in sign.

The complete normal to S at (x, t) is clearly $\boldsymbol{\nu} = (\boldsymbol{\nu}_x, \nu_t)$, where

$$\begin{aligned} \boldsymbol{\nu}_x &= \frac{D\Phi(x, t)}{|\nabla\Phi(x, t)|} = \mathbf{n} \frac{|D\Phi(x, t)|}{|\nabla\Phi(x, t)|}, \\ \nu_t &= \frac{\Phi_t(x, t)}{|\nabla\Phi(x, t)|}. \end{aligned}$$

2.2. Smooth weak solutions, with smooth interfaces, are classical solutions. Let us assume that a function u satisfies

$$\begin{aligned} u &> 0, & \text{in } A, \\ u &< 0, & \text{in } B, \end{aligned}$$

and that $u = 0$ on the common portion of the boundaries of the open sets $A, B \subset \mathbf{R}^{N+1}$. We assume this portion to be a smooth surface S , with complete normal $\boldsymbol{\nu} = (\boldsymbol{\nu}_x, \nu_t)$ and spatial normal \mathbf{n} , according to the notation above. Let $\boldsymbol{\nu}$ be the outer normal to B . Moreover assume

$$u, f \in C(\overline{A \cup B}), \quad u|_A \in C^{2,1}(\overline{A}), \quad u|_B \in C^{2,1}(\overline{B}).$$

Finally, assume v (defined as in (1.3)) is a weak solution of (1.7), for any smooth φ whose support is contained in the interior of $A \cup B \cup S$. It will be apparent from our calculations that the definition of v at $u = 0$ is not relevant, in this case, essentially because the $N + 1$ -dimensional measure of the free boundary $u = 0$ is zero.

By direct calculation we have, owing to the regularity of u and of v ,

$$\begin{aligned} \iint_A v \varphi_t \, dx \, dt &= - \int_S \varphi E(0+) \nu_t \, d\sigma - \iint_A v_t \varphi \, dx \, dt, \\ \iint_B v \varphi_t \, dx \, dt &= \int_S \varphi E(0-) \nu_t \, d\sigma - \iint_B v_t \varphi \, dx \, dt. \end{aligned}$$

On adding these two equalities we find, recalling the definition of E ,

$$\iint_{A \cup B} v \varphi_t \, dx \, dt = - \int_S \varphi \nu_t \, d\sigma - \iint_{A \cup B} u_t \varphi \, dx \, dt, \quad (2.3)$$

since $v_t = u_t$ both in A and in B . The space part of the differential operator in (1.7) is treated similarly

$$\begin{aligned} \iint_A Du \cdot D\varphi \, dx \, dt &= - \int_S Du \cdot \nu_x \, d\sigma - \iint_A \varphi \Delta u \, dx \, dt, \\ \iint_B Du \cdot D\varphi \, dx \, dt &= \int_S Du \cdot \nu_x \, d\sigma - \iint_B \varphi \Delta u \, dx \, dt. \end{aligned}$$

Again, on adding these two equalities we find

$$\iint_{A \cup B} Du \cdot D\varphi \, dx \, dt = \int_S [Du^B - Du^A] \cdot \nu_x \, d\sigma - \iint_{A \cup B} \varphi \Delta u \, dx \, dt, \quad (2.4)$$

where we denote by Du^A [Du^B] the trace on S of the spatial gradient of the restriction of u to A [B]. Combining (2.3) with (2.4) we arrive at

$$\begin{aligned} \iint_{A \cup B} f \varphi \, dx \, dt &= \iint_{A \cup B} \{-v \varphi_t + Du \cdot D\varphi\} \, dx \, dt = \int_S \varphi [\nu_t + Du^B \cdot \nu_x - Du^A \cdot \nu_x] \, d\sigma \\ &\quad + \iint_{A \cup B} \varphi \{u_t - \Delta u\} \, dx \, dt. \end{aligned} \quad (2.5)$$

Taking an arbitrary smooth φ supported in A , we immediately find that in A

$$u_t - \Delta u = f. \quad (2.6)$$

Of course the same PDE holds in B , by the same token.

Hence, we may drop the last integral in (2.5). Then take $\varphi = \varphi_\varepsilon$, where for all $\varepsilon > 0$

$$\varphi_\varepsilon|_S = \psi \in C_0^1(S); \quad |\varphi_\varepsilon| \leq 1; \quad |\text{supp } \varphi_\varepsilon|_{N+1} \rightarrow 0, \quad \text{as } \varepsilon \rightarrow 0.$$

Then, taking $\varepsilon \rightarrow 0$ in (2.5) we get

$$\int_S \psi [\nu_t + Du^B \cdot \nu_x - Du^A \cdot \nu_x] \, d\sigma = 0.$$

As ψ is reasonably arbitrary, it follows that on S

$$Du^B \cdot \nu_x - Du^A \cdot \nu_x = -\nu_t.$$

This condition can be rewritten as

$$V = Du^B \cdot \mathbf{n} - Du^A \cdot \mathbf{n}, \quad (2.7)$$

and is the multi-dimensional equivalent of the Stefan condition (1.5) of Chapter 1. In fact, it could be directly derived from an energetical balance argument, as we did for (1.5) of Chapter 1. In this last approach, the weak formulation of the Stefan problem follows from (2.7) and from the heat equation which we assume to hold in A and in B separately: we only need go over our previous calculations in reverse order.

The case where either $v \equiv 1$ in A or $v \equiv 0$ in B can be treated similarly.

2.3. Some smooth weak solutions are not classical solutions. Let us consider the following problem

$$v_t - u_{xx} = 1, \quad \text{in } Q_T = (0, 1) \times (0, +\infty), \quad (2.8)$$

$$u(x, 0) = -1, \quad 0 < x < 1, \quad (2.9)$$

$$u_x(0, t) = 0, \quad 0 < t, \quad (2.10)$$

$$u_x(1, t) = 0, \quad 0 < t \quad (2.11)$$

(see [15]). We perform only a local analysis of the problem in the interior of the domain Q_T , giving for granted the solutions below actually take the boundary data (in a suitable sense).

If, instead of (2.8), the standard heat equation

$$u_t - u_{xx} = 1$$

was prescribed, clearly the solution to the initial value boundary problem would be

$$u(x, t) = -1 + t, \quad 0 < x < 1, \quad 0 < t.$$

Let us check that this function can not be a solution to the Stefan problem above. Otherwise, we would have

$$v(x, t) = -1 + t, \quad 0 < t < 1; \quad v(x, t) = t, \quad 1 < t.$$

Thus for every $\varphi \in C_0^\infty(Q_T)$,

$$\iint_{Q_T} \{-v\varphi_t + u_x\varphi_x\} dx dt = - \iint_{Q_T} v\varphi_t dx dt = \iint_{Q_T} \varphi dx dt + \int_0^1 \varphi(x, 1) dx.$$

The last integral in this equality is evidently spurious, on comparison with the weak formulation (1.7).

Let us instead check that a solution (actually the unique solution, see Section 4) to (2.8)–(2.11) is given by

$$v(x, t) = -1 + t, \quad 0 < t; \quad u(x, t) = \begin{cases} -1 + t, & 0 < t < 1, \\ 0, & 1 < t < 2, \\ -2 + t, & 2 < t. \end{cases}$$

It is immediately checked that (1.7) is fulfilled. *We still have to check that (1.5) holds*, that is that v is an admissible enthalpy for u . Again, this follows immediately from the definitions.

The above can be interpreted as follows: the enthalpy v grows in time accordingly to the prescribed volumetric source; the change of phase takes place *over the time interval* $1 < t < 2$, because this is the time interval where $v \in (0, 1)$; over this time interval, therefore, the temperature equals the critical temperature $u = 0$;

for all other times, (2.8) coincides with the standard heat equation, and thus u is simply the solution to a suitable problem for the heat equation.

Note that the set $u = 0$ has in this example positive measure, in contrast with the classical formulation of Chapter 1. See also [8], [1] for a discussion of existence and non existence of mushy regions in weak solutions to change of phase problems.

2.4. Without sign restrictions, classical solutions may not be weak solutions. Let us go back to problem (2.9)–(2.14) of Chapter 1, where we now assume $u_0 \in C^1([0, b])$, $u_0(b) = 0$, $u_0(x) < 0$ for $0 \leq x < b$, and, e.g., $h \equiv 0$. It can be shown (see [6]) that this problem has a classical solution, in the sense of Definition 2.1 of Chapter 1, at least for a small enough $T > 0$. Note that the Stefan condition (2.12) of Chapter 1 has now the ‘wrong’ sign (cf. Exercise 1.2 of Chapter 1). Therefore the classical solution at hand is *not* a solution of the weak formulation. Indeed, otherwise it would be a smooth weak solution with a smooth free boundary, and we would be able to infer the Stefan condition as above. However, as shown above, this condition would be the one ‘correctly’ corresponding to the actual sign of the solution, and therefore would be *different* from the one we prescribed.

More generally, no undercooling is possible in the weak formulation introduced here. In fact, the liquid and the solid phases are identified solely by the value of v . Thus, whenever u changes its sign a change of phase must take place. This is not the case in the classical formulation, where the liquid and solid phases are essentially identified by a topological argument, as the two connected components of the domain, separated by the special level surface which is *defined* as the free boundary. Other level surfaces corresponding to the value $u = 0$ may exist inside both phases.

2.5. Exercises.

2.1. Assume that the interior M of the region $\{u = 0\}$ is non empty, where u is given by (1.4), and v satisfies (1.7). Show that, in a suitable weak sense, $v_t = f$ in M .

3. Definition of weak solution

Let us define the ‘inverse’ of the graph E in (1.6). This is the function ϑ given by

$$\vartheta(r) = \begin{cases} r, & r \leq 0, \\ 0, & 0 < r < 1, \\ r - 1, & 1 \leq r. \end{cases} \quad (3.1)$$

Let $Q_T = \Omega \times (0, T)$, where $\Omega \subset \mathbf{R}^N$ is a bounded open set with boundary of class C^∞ .

Let us consider the Stefan problem

$$v_t - \Delta \vartheta(v) = f(v), \quad \text{in } Q_T, \quad (3.2)$$

$$v(x, 0) = v_0(x), \quad x \in \Omega, \quad (3.3)$$

$$\frac{\partial \vartheta(v)}{\partial \mathbf{n}} = 0, \quad \text{on } \partial\Omega \times (0, T), \quad (3.4)$$

where $v_0 \in L^\infty(\Omega)$ and $f \in L^\infty(\mathbf{R}) \cap C^\infty(\mathbf{R})$ are given functions. We assume that for a fixed $\mu > 0$

$$|f(v_1) - f(v_2)| \leq \mu |v_1 - v_2|, \quad \text{for all } v_1, v_2 \in \mathbf{R}. \quad (3.5)$$

DEFINITION 3.1. A function $v \in L^\infty(Q_T)$ is a weak solution to (3.2)–(3.4) if

$$u := \vartheta(v) \in L^2(0, T; W_1^2(\Omega)), \quad (3.6)$$

and for all $\varphi \in W_1^2(Q_T)$ such that $\varphi(x, T) = 0$ we have

$$\iint_{Q_T} \{-v\varphi_t + Du \cdot D\varphi\} dx dt = \int_{\Omega} v_0(x)\varphi(x, 0) dx + \iint_{Q_T} f(v)\varphi dx dt. \quad (3.7)$$

Note that equation (3.7) is obtained integrating formally by parts equation (3.2), after multiplying it by a φ as above.

Of course the structure of the problem could be generalized; for example the smoothness required of $\partial\Omega$ can be reduced by approximating Ω with more regular domains (but (3.5) is going to play an essential role). However we aim here at showing some basic techniques in the simple setting above, which is suitable for our purposes.

REMARK 3.1. Actually, if v is a weak solution to the Stefan problem (in a sense similar to ours), the corresponding temperature u is continuous in Q_T (see [4]), a fact which however we won't use here.

3.1. Exercises.

3.1. Assume $u \in C(Q_T)$ (see also Remark 3.1). Show that u is of class C^∞ where it is not zero.

4. Uniqueness of the weak solution

4.1. A different notion of weak solution. If we assume in (3.7) that

$$\text{i) } \varphi \in W_{2,1}^2(Q_T); \quad \text{ii) } \varphi(x, T) = 0; \quad \text{iii) } \frac{\partial\varphi}{\partial\mathbf{n}} = 0, \quad \text{on } \partial\Omega \times (0, T); \quad (4.1)$$

we immediately obtain, on integrating once by parts,

$$-\iint_{Q_T} \{v\varphi_t + u \Delta \varphi\} dx dt = \int_{\Omega} v_0(x)\varphi(x, 0) dx + \iint_{Q_T} f(v)\varphi dx dt. \quad (4.2)$$

We need drop the requirement $\varphi(x, T) = 0$, for technical reasons. This can be done as follows. Choose a φ satisfying i), iii) of (4.1), but not necessarily ii). Fix $t \in (0, T)$, and define for $0 < \varepsilon < t$ (see Figure 2)

$$\chi_\varepsilon(\tau) = \min\left(1, \frac{1}{\varepsilon}(t - \tau)_+\right).$$

The function $\varphi\chi_\varepsilon$ satisfies requirement (4.1) in full, so that it can be taken as a testing function in (4.2). Let us rewrite it as

$$-\iint_{Q_T} v[\varphi\chi_\varepsilon]_\tau dx d\tau = \int_{\Omega} v_0(x)\varphi(x, 0) dx + \iint_{Q_T} \{u \Delta \varphi + f(v)\varphi\}\chi_\varepsilon dx d\tau.$$

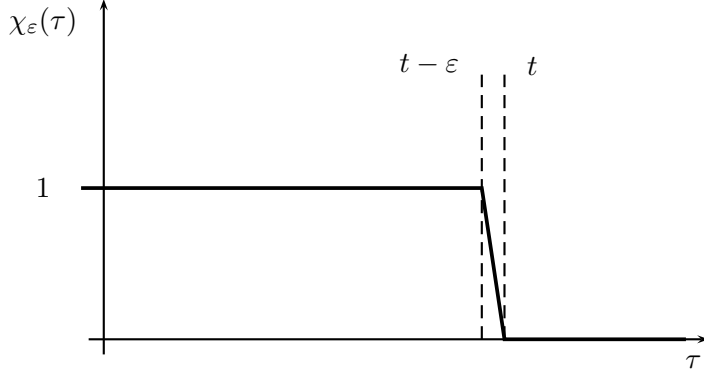
FIGURE 2. The auxiliary function χ_ε .

The behaviour of the right hand side as $\varepsilon \rightarrow 0$ is obvious. The left hand side equals

$$-\iint_{Q_T} v \varphi_\tau \chi_\varepsilon \, dx \, d\tau + \frac{1}{\varepsilon} \int_{t-\varepsilon}^t \int_{\Omega} v(x, \tau) \varphi(x, \tau) \, dx \, d\tau.$$

On letting $\varepsilon \rightarrow 0$ in this quantity we get, for almost all $t \in (0, T)$

$$-\iint_{Q_t} v \varphi_\tau \, dx \, d\tau + \int_{\Omega} v(x, t) \varphi(x, t) \, dx.$$

Thus the definition of weak solution given above actually implies the new (and weaker) one

DEFINITION 4.1. A function $v \in L^\infty(Q_T)$ is a weak solution of class L^∞ to (3.2)–(3.4) if for all $\varphi \in W_{2,1}^2(Q_T)$ such that $\frac{\partial \varphi}{\partial \mathbf{n}} = 0$ on $\partial\Omega \times (0, T)$ we have

$$\begin{aligned} \int_{\Omega} v(x, t) \varphi(x, t) \, dx - \iint_{Q_t} \{v \varphi_\tau + u \Delta \varphi\} \, dx \, d\tau \\ = \int_{\Omega} v_0(x) \varphi(x, 0) \, dx + \iint_{Q_t} f(v) \varphi \, dx \, d\tau, \end{aligned} \quad (4.3)$$

for almost all $t \in (0, T)$. Here $u = \vartheta(v)$.

Note that we dropped in Definition 4.1 any regularity requirement for v (excepting boundedness).

REMARK 4.1. It follows from (4.3) that the function

$$t \mapsto \int_{\Omega} v(x, t) \varphi(x, t) \, dx$$

is actually continuous over $[0, T]$, up to modification of v over sets of zero measure.

4.2. Continuous dependence on the initial data. We are now in a position to prove

THEOREM 4.1. (CONTINUOUS DEPENDENCE ON THE DATA) *Let v_1, v_2 be two weak solutions of class L^∞ to (3.2)–(3.4), in the sense of Definition 4.1 (or two weak solutions in the sense of Definition 3.1), corresponding to bounded initial data v_{01}, v_{02} respectively. Then, for almost all $0 < t < T$*

$$\int_{\Omega} |v_1(x, t) - v_2(x, t)| dx \leq e^{\mu t} \int_{\Omega} |v_{01}(x) - v_{02}(x)| dx. \quad (4.4)$$

COROLLARY 4.1. (UNIQUENESS) *Let v_1, v_2 be two weak solutions of class L^∞ to (3.2)–(3.4), in the sense of Definition 4.1 (or two weak solutions in the sense of Definition 3.1), corresponding to the same bounded initial data. Then $v_1 \equiv v_2$ in Q_T .*

REMARK 4.2. (SOLUTIONS OF CLASS L^1) Both Theorem 4.1 and its immediate Corollary 4.1 actually hold for a more general class of weak solutions, obtained replacing the requirement $v \in L^\infty(Q_T)$ in Definition 4.1 with $v \in L^1(Q_T)$. Also the initial data may be selected out of $L^1(\Omega)$. In this connection, in order to keep the integrals in (4.3) meaningful, we have to assume that φ is a Lipschitz continuous function in Q_T , with $\varphi_{x_i x_j} \in L^\infty(Q_T)$, $i, j = 1, \dots, N$, and $\frac{\partial \varphi}{\partial n} = 0$ on $\partial\Omega \times (0, T)$.

Once existence of solutions in the sense of Definition 4.1 has been obtained, existence of solutions of class L^1 can be proven as follows. Assume $v_0 \in L^1(\Omega)$, and $v_0^i \rightarrow v_0$ in $L^1(\Omega)$, $v_0^i \in L^\infty(\Omega)$. Note that the solutions v^i of class L^∞ corresponding to the approximating initial data v_0^i satisfy (4.4). Therefore $\{v^i\}$ is a Cauchy sequence in $L^1(Q_T)$, and we may assume it converges to a $v \in L^1(Q_T)$ both in the sense of $L^1(Q_T)$, and a.e. in Q_T . It is now a trivial task to take the limit in the weak formulation (4.3) satisfied by v^i and obtain the corresponding formulation for v .

Standard references for the material in this Section are [11], Chapter V, Section 9, and [12], whose approach we follow, with some modifications.

4.3. Proof of Theorem 4.1. Fix $t \in (0, T)$. Subtract from each other the two equations (4.3) written for the two solutions, and obtain

$$\begin{aligned} & \int_{\Omega} [v_1(x, t) - v_2(x, t)] \varphi(x, t) dx - \iint_{Q_t} (v_1 - v_2) [\varphi_\tau + a(x, t) \Delta \varphi] dx d\tau \\ &= \int_{\Omega} [v_{01}(x) - v_{02}(x)] \varphi(x, 0) dx + \iint_{Q_t} [f(v_1) - f(v_2)] \varphi dx d\tau, \end{aligned} \quad (4.5)$$

where we set

$$\begin{aligned} a(x, t) &= \frac{\vartheta(v_1(x, t)) - \vartheta(v_2(x, t))}{v_1(x, t) - v_2(x, t)}, & v_1(x, t) &\neq v_2(x, t), \\ a(x, t) &= 0, & v_1(x, t) &= v_2(x, t). \end{aligned}$$

Due to the definition of ϑ we have

$$0 \leq a(x, t) \leq 1, \quad \text{in } Q_T. \quad (4.6)$$

Next choose $\varphi = \varphi_\varepsilon$, where for each $\varepsilon > 0$, φ_ε is the solution of

$$\varphi_{\varepsilon\tau} + (a_\varepsilon(x, t) + \varepsilon) \Delta \varphi_\varepsilon = 0, \quad \text{in } Q_t, \quad (4.7)$$

$$\varphi(x, t) = \Phi(x), \quad x \in \Omega, \quad (4.8)$$

$$\frac{\partial \varphi}{\partial \mathbf{n}} = 0, \quad \text{on } \partial\Omega \times (0, t). \quad (4.9)$$

Here $\Phi \in C_0^\infty(\Omega)$, $|\Phi(x)| \leq 1$, and $a_\varepsilon \in C^\infty(\overline{Q_T})$ satisfies

$$0 \leq a_\varepsilon \leq 1, \quad \text{a.e. in } Q_T; \quad \|a_\varepsilon - a\|_2 \leq \varepsilon. \quad (4.10)$$

Some relevant properties of φ_ε are collected in Lemma 4.1 below. Note that (4.8) is the initial value for the ‘reverse’ parabolic problem solved by φ_ε . By virtue of (4.15) we have as $\varepsilon \rightarrow 0$

$$\begin{aligned} \iint_{Q_t} \varepsilon |\Delta \varphi_\varepsilon| \, dx \, d\tau &\leq \left(\iint_{Q_t} \varepsilon \, dx \, d\tau \right)^{1/2} \left(\iint_{Q_t} \varepsilon (\Delta \varphi_\varepsilon)^2 \, dx \, d\tau \right)^{1/2} \\ &\leq \sqrt{2t\varepsilon} \|D\Phi\|_{2,\Omega} |\Omega|^{1/2} \rightarrow 0, \end{aligned}$$

as well as (using (4.10))

$$\begin{aligned} \iint_{Q_t} |a_\varepsilon - a| |\Delta \varphi_\varepsilon| \, dx \, d\tau &\leq \left(\iint_{Q_t} \frac{|a_\varepsilon - a|^2}{\varepsilon} \, dx \, d\tau \right)^{1/2} \left(\iint_{Q_t} \varepsilon (\Delta \varphi_\varepsilon)^2 \, dx \, d\tau \right)^{1/2} \\ &\leq \sqrt{2\varepsilon} \|D\Phi\|_{2,\Omega} \rightarrow 0. \end{aligned}$$

Moreover, using (4.7) in (4.5), and (4.16), we get

$$\begin{aligned} \int_{\Omega(t)} [v_1 - v_2] \Phi \, dx &= \iint_{Q_t} [a - a_\varepsilon - \varepsilon] \Delta \varphi_\varepsilon [v_1 - v_2] \, dx \, d\tau + \int_{\Omega} [v_{01} - v_{02}] \varphi_\varepsilon(x, 0) \, dx \\ &+ \iint_{Q_t} [f(v_1) - f(v_2)] \varphi_\varepsilon \, dx \, d\tau \leq (\|v_1\|_\infty + \|v_2\|_\infty) \iint_{Q_t} [|a - a_\varepsilon| + \varepsilon] |\Delta \varphi_\varepsilon| \, dx \, d\tau \\ &+ \int_{\Omega} |v_{01} - v_{02}| \, dx + \mu \iint_{Q_t} |v_1 - v_2| \, dx \, d\tau. \end{aligned}$$

As $\varepsilon \rightarrow 0$ this yields

$$\int_{\Omega(t)} [v_1 - v_2] \Phi \, dx \leq \int_{\Omega} |v_{01} - v_{02}| \, dx + \mu \int_0^t \int_{\Omega(\tau)} |v_1 - v_2| \, dx \, d\tau. \quad (4.11)$$

Choose now $\Phi = \Phi_n$, where for $n \rightarrow \infty$

$$\Phi_n(x) \rightarrow \text{sign}(v_1(x, t) - v_2(x, t)), \quad \text{a.e. } x \in \Omega.$$

On letting $n \rightarrow \infty$ in (4.11) we obtain

$$\int_{\Omega(t)} |v_1 - v_2| \, dx \leq \int_{\Omega} |v_{01} - v_{02}| \, dx + \mu \int_0^t \int_{\Omega(\tau)} |v_1 - v_2| \, dx \, d\tau.$$

The statement now follows simply invoking Gronwall’s lemma.

LEMMA 4.1. *Let $\alpha \in C^\infty(\overline{Q_T})$, $0 < \varepsilon \leq \alpha \leq \alpha_0$, where ε and α_0 are given constants. Let $\Phi \in C_0^\infty(\Omega)$. Then there exists a unique solution $\varphi \in C^\infty(\overline{Q_T})$ of*

$$\varphi_t - \alpha \Delta \varphi = 0, \quad \text{in } Q_T, \quad (4.12)$$

$$\varphi(x, 0) = \Phi(x), \quad x \in \Omega, \quad (4.13)$$

$$\frac{\partial \varphi}{\partial \mathbf{n}} = 0, \quad \text{on } \partial\Omega \times (0, T), \quad (4.14)$$

such that for all $0 < t < T$

$$\iint_{Q_t} (\varphi_\tau^2 + \alpha (\Delta \varphi)^2) dx d\tau + \int_{\Omega(t)} |D\varphi|^2 dx \leq (\alpha_0 + 1) \int_{\Omega} |D\Phi|^2 dx. \quad (4.15)$$

Moreover

$$\|\varphi\|_\infty \leq \|\Phi\|_\infty. \quad (4.16)$$

PROOF. The existence of a unique solution $\varphi \in C^\infty(\overline{Q_T})$ to (4.12)–(4.14) is a classical result. Let us multiply (4.12) by $\Delta \varphi$, and integrate by parts over Q_t , for an arbitrarily fixed $t \in (0, T)$. We find

$$\begin{aligned} \iint_{Q_t} \alpha |\Delta \varphi|^2 dx d\tau &= \iint_{Q_t} \varphi_\tau \Delta \varphi dx d\tau = - \iint_{Q_t} D\varphi_\tau \cdot D\varphi dx d\tau \\ &= \frac{1}{2} \int_{\Omega} |D\varphi(x, 0)|^2 dx - \frac{1}{2} \int_{\Omega} |D\varphi(x, t)|^2 dx. \end{aligned}$$

Using again (4.12) we obtain

$$\iint_{Q_t} \varphi_\tau^2 dx d\tau = \iint_{Q_t} \alpha^2 |\Delta \varphi|^2 dx d\tau \leq \frac{\alpha_0}{2} \int_{\Omega} |D\varphi(x, 0)|^2 dx.$$

Thus, φ satisfies the integral estimate (4.15). The bound in (4.16) is an obvious consequence of the maximum and boundary point principles of Appendix A. \square

4.4. Exercises.

4.1. Prove that

$$\Phi \geq 0 \text{ } [\leq 0] \implies \varphi_\varepsilon \geq 0 \text{ } [\leq 0]$$

where φ_ε is the solution to (4.7)–(4.9). Use this fact to prove the comparison result

$$v_{01} \leq v_{02} \text{ in } \Omega \implies v_1 \leq v_2 \text{ in } Q_T,$$

where v_1 and v_2 are as in Theorem 4.1, provided $f' \geq 0$.

4.2. If $\Phi \in C^\infty(\overline{\Omega})$, but $\Phi \notin C_0^\infty(\Omega)$, φ as in Lemma 4.1 need not be even $C^1(\overline{Q_T})$. Why?

5. Existence of weak solutions

We apply here the ideas of [8], though we approximate the Stefan problem with smooth parabolic problems, rather than discretizing it in time.

THEOREM 5.1. *There exists a weak solution v to (3.2)–(3.4), in the sense of Definition 3.1, satisfying*

$$\|v\|_\infty \leq \|v_0\|_\infty. \quad (5.1)$$

The proof of this existence result relies on an approximation procedure. Namely, we approximate (3.2)–(3.4) with a sequence of smoothed problems; the solutions to these problems in turn approach a solution to the original Stefan problem.

We need a sequence of smooth constitutive functions $\vartheta_n \in C^\infty(\mathbf{R}^N)$ approximating ϑ , such that

$$\frac{1}{n} \leq \vartheta'_n(s) \leq 1, \quad s \in \mathbf{R}; \quad \vartheta_n \rightarrow \vartheta, \quad \text{uniformly in } \mathbf{R}. \quad (5.2)$$

Clearly we may assume

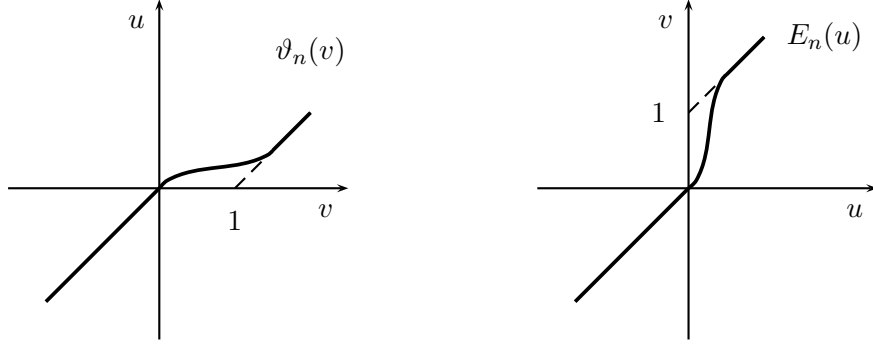

FIGURE 3. The approximating functions ϑ_n and E_n .

$$\vartheta(s) \leq \vartheta_n(s) \leq \vartheta(s) + \frac{1}{n}, \quad s \in \mathbf{R}; \quad \vartheta(s) = \vartheta_n(s) = s, \quad s < 0. \quad (5.3)$$

Define E_n as the inverse function of ϑ_n . Then

$$E_n(s) \leq E(s), \quad s \in \mathbf{R}; \quad E(s) = E_n(s) = s, \quad s < 0. \quad (5.4)$$

Let us also introduce a sequence $v_{0n} \in C_0^\infty(\Omega)$ approximating the initial data as in

$$v_{0n} \rightarrow v_0, \quad \text{a.e. in } \Omega; \quad \|v_{0n}\|_\infty \leq \|v_0\|_\infty. \quad (5.5)$$

For each n there exists a unique solution $v_n \in C^\infty(\overline{Q_T})$ to

$$v_{nt} - \Delta \vartheta_n(v_n) = f(v_n)\eta_n, \quad \text{in } Q_T, \quad (5.6)$$

$$\frac{\partial \vartheta_n(v_n)}{\partial \mathbf{n}} = 0, \quad \text{on } \partial\Omega \times (0, T), \quad (5.7)$$

$$v_n(x, 0) = v_{0n}(x), \quad \text{in } \Omega, \quad (5.8)$$

where $\eta_n \in C_0^\infty(\Omega)$ is such that

$$\eta_n(x) = 1, \quad \text{dist}(x, \partial\Omega) > \frac{1}{n}; \quad 0 \leq \eta_n(x) \leq 1, \quad x \in \Omega.$$

Let us denote $u_n = \vartheta_n(v_n)$, and rewrite (5.6) as

$$E_n(u_n)_t - \Delta u_n = f(v_n)\eta_n, \quad \text{in } Q_T. \quad (5.9)$$

Owing to the maximum principle (see Theorem 1.2 of Appendix A), we have

$$\|u_n\|_\infty \leq \|v_n\|_\infty \leq \|v_0\|_\infty + T\|f\|_\infty =: M. \quad (5.10)$$

5.1. The energy inequality. Multiply (5.9) by u_n and integrate by parts. Note that

$$E_n(u_n)_t u_n = \frac{\partial}{\partial t} \int_0^{u_n} E'_n(s) s \, ds,$$

and that, if $k > 0$, taking into account (5.2),

$$\frac{k^2}{2} \leq \int_0^k E'_n(s) s \, ds \leq E_n(k) k \leq (k+1)k.$$

If $k < 0$ we simply have

$$\int_0^k E'_n(s) s \, ds = \frac{k^2}{2}.$$

Therefore we obtain after standard calculations, for each $t \in (0, T)$

$$\begin{aligned} \frac{1}{2} \int_{\Omega} u_n(x, t)^2 \, dx + \iint_{Q_t} |Du_n|^2 \, dx \, d\tau \\ \leq \frac{1}{2} \int_{\Omega} |\vartheta_n(v_{0n})| (|\vartheta_n(v_{0n})| + 1) \, dx + \iint_{Q_t} f(v_n) \eta_n u_n \, dx \, d\tau \\ \leq \frac{|\Omega|}{2} (\|v_0\|_{\infty} + 1)^2 + \|f\|_{\infty} M |\Omega| T. \end{aligned}$$

Note that both terms on the leftmost side of this estimate are positive. Dropping either one, taking the supremum in time, and collecting the two bounds so obtained, we get

$$\sup_{0 < t < T} \int_{\Omega} u_n(x, t)^2 \, dx + \iint_{Q_T} |Du_n|^2 \, dx \, d\tau \leq C, \quad (5.11)$$

where $C > 0$ is a constant depending on the data of the problem, but not on n . It follows that we may extract a subsequence, still labelled by n , such that

$$u_n \rightarrow u, \quad Du_n \rightarrow Du, \quad \text{weakly in } L^2(Q_T). \quad (5.12)$$

Moreover we have

$$\|u\|_{\infty} \leq M, \quad (5.13)$$

and

$$\sup_{0 < t < T} \int_{\Omega} u(x, t)^2 \, dx + \iint_{Q_T} |Du|^2 \, dx \, d\tau \leq C. \quad (5.14)$$

We may as well assume

$$v_n \rightarrow v, \quad \text{weakly in } L^2(Q_T), \quad (5.15)$$

but note that, due to the nonlinear nature of our problem (i.e., the fact that E and f are not linear functions), weak convergence is not enough to pass to the limit in the weak formulation of the approximating problem, i.e., in

$$\iint_{Q_T} \{-v_n \varphi_t + Du_n \cdot D\varphi\} \, dx \, dt = \int_{\Omega} v_{0n}(x) \varphi(x, 0) \, dx + \iint_{Q_T} f(v_n) \eta_n \varphi \, dx \, dt, \quad (5.16)$$

where φ is any function out of $W_1^2(Q_T)$ with $\varphi(x, T) = 0$. For example we do not know that v is an admissible enthalpy for u . We must therefore obtain some stronger kind of convergence for the sequence v_n , so that, e.g., $f(v_n)$ converges to $f(v)$.

However we do have some compactness in suitable integral norms for the sequence u_n , due to (5.11). More specifically, let $h \in \mathbf{R}^N$ be any given vector with length $0 < |h| < \delta$, and let $\mathbf{k} = h/|h|$. Setting

$$\Omega_\delta = \{x \in \Omega \mid \text{dist}(x, \partial\Omega) > \delta\},$$

we calculate, by a standard argument,

$$\begin{aligned} \int_0^T \int_{\Omega_\delta} |u_n(x+h, t) - u_n(x, t)| \, dx \, dt &= \int_0^T \int_{\Omega_\delta} \left| \int_0^{|h|} Du_n(x+s\mathbf{k}) \cdot \mathbf{k} \, ds \right| \, dx \, dt \\ &\leq \int_0^T \int_{\Omega_\delta} \int_0^{|h|} |Du_n(x+s\mathbf{k})| \, ds \, dx \, dt = \int_0^T \int_0^{|h|} \int_{\Omega_\delta} |Du_n(x+s\mathbf{k})| \, dx \, ds \, dt \\ &\leq \int_0^T \int_0^{|h|} \int_{\Omega} |Du_n(x)| \, dx \, ds \, dt = |h| \int_0^T \int_{\Omega} |Du_n(x)| \, dx \, dt \leq C|h|. \end{aligned} \quad (5.17)$$

We have used the fact that $x+s\mathbf{k} \in \Omega$ for all $x \in \Omega_\delta$ and all $0 < s < |h|$, and (5.11).

5.2. The BV estimate. Introduce a cut off function $\zeta \in C^\infty(\Omega)$ such that

$$\begin{aligned} \zeta(x) &\equiv 1, \quad \text{dist}(x, \partial\Omega) > 4\delta; & \zeta(x) &\equiv 0, \quad \text{dist}(x, \partial\Omega) < 2\delta; \\ |D\zeta| &\leq \frac{\gamma}{\delta}; & |\Delta\zeta| &\leq \frac{\gamma}{\delta^2}; \end{aligned}$$

where γ does not depend on δ . We may also assume that $n > 1/\delta$, so that $\eta_n \zeta \equiv \zeta$ in Ω .

In this Subsection we drop the index n , for ease of notation. Therefore we write ϑ for ϑ_n , v for v_n , and so on. For a given $h \in \mathbf{R}^N$ define the testing function

$$\varphi(x, t) = \text{sign}_\varepsilon(\vartheta(v(x+h, t)) - \vartheta(v(x, t)))\zeta(x),$$

where $\text{sign}_\varepsilon \in C^\infty(\mathbf{R})$ is a smooth approximation of sign , such that

$$\text{sign}_\varepsilon(s) \rightarrow \text{sign}(s), \quad s \in \mathbf{R}, \quad \text{sign}'_\varepsilon \geq 0$$

(we set $\text{sign}(0) = \text{sign}_\varepsilon(0) = 0$). Let us denote

$$\varphi_h(x, t) = \varphi(x-h, t).$$

If $|h| < \delta$, which we assume from now on, both φ and φ_h vanish in a neighbourhood of $\partial\Omega \times (0, T)$.

Multiply (5.6) by φ and integrate by parts, obtaining

$$\iint_{Q_t} v_\tau \varphi \, dx \, d\tau + \iint_{Q_t} D\vartheta(v) \cdot D\varphi \, dx \, d\tau = \iint_{Q_t} f(v)\varphi \, dx \, d\tau. \quad (5.18)$$

On performing the same operation with φ_h , we obtain

$$\begin{aligned} \iint_{Q_t} v_\tau(x, \tau) \varphi(x - h, \tau) \, dx \, d\tau + \iint_{Q_t} D\vartheta(v(x, \tau)) \cdot D\varphi(x - h, \tau) \, dx \, d\tau \\ = \iint_{Q_t} f(v(x, \tau)) \varphi(x - h, \tau) \, dx \, d\tau. \end{aligned} \quad (5.19)$$

Let us change the integration variable in (5.19),

$$x - h \mapsto y.$$

The domain of integration stays the same (i.e., Q_t) because

$$\text{supp } \varphi_h \subset Q_T, \quad \text{supp } \varphi \subset Q_T.$$

Still denoting the new variable by x we obtain

$$\begin{aligned} \iint_{Q_t} v_\tau(x + h, \tau) \varphi(x, \tau) \, dx \, d\tau + \iint_{Q_t} D\vartheta(v(x + h, \tau)) \cdot D\varphi(x, \tau) \, dx \, d\tau \\ = \iint_{Q_t} f(v(x + h, \tau)) \varphi(x, \tau) \, dx \, d\tau. \end{aligned} \quad (5.20)$$

On subtracting (5.18) from (5.20), and explicitly calculating $D\varphi$, we arrive at

$$\begin{aligned} \iint_{Q_t} [v_\tau(x + h, \tau) - v_\tau(x, \tau)]_\tau \varphi(x, \tau) \, dx \, d\tau \\ + \iint_{Q_t} |D\vartheta(v(x + h, \tau)) - D\vartheta(v(x, \tau))|^2 \text{sign}'_\varepsilon(\dots) \zeta \, dx \, d\tau \\ + \iint_{Q_t} [D\vartheta(v(x + h, \tau)) - D\vartheta(v(x, \tau))] \cdot D\zeta \text{sign}_\varepsilon(\dots) \, dx \, d\tau \\ = \iint_{Q_t} [f(v(x + h, \tau)) - f(v(x, \tau))] \varphi(x, \tau) \, dx \, d\tau. \end{aligned} \quad (5.21)$$

The second integral in (5.21) may be dropped, since it is non negative. Next note

$$v(x + h, \tau) \begin{matrix} > \\ = \\ < \end{matrix} v(x, \tau) \iff \vartheta(v(x + h, \tau)) \begin{matrix} > \\ = \\ < \end{matrix} \vartheta(v(x, \tau)),$$

as $\vartheta = \vartheta_n$ is strictly increasing. Thus, as $\varepsilon \rightarrow 0$

$$\begin{aligned} \text{sign}_\varepsilon(\vartheta(v(x + h, \tau)) - \vartheta(v(x, \tau))) &\rightarrow \text{sign}(\vartheta(v(x + h, \tau)) - \vartheta(v(x, \tau))) \\ &= \text{sign}(v(x + h, \tau) - v(x, \tau)) =: \sigma(x, \tau). \end{aligned}$$

Finally, we may take the limit $\varepsilon \rightarrow 0$ in (5.21), after dropping the second integral as we said, to find

$$\begin{aligned} & \iint_{Q_t} [v_\tau(x+h, \tau) - v_\tau(x, \tau)] \sigma(x, \tau) \zeta(x) \, dx \, d\tau \\ & + \iint_{Q_t} [D\vartheta(v(x+h, \tau)) - D\vartheta(v(x, \tau))] \cdot D\zeta \sigma(x, \tau) \, dx \, d\tau \\ & \leq \iint_{Q_t} [f(v(x+h, \tau)) - f(v(x, \tau))] \sigma(x, \tau) \zeta \, dx \, d\tau. \end{aligned} \quad (5.22)$$

The first integral in (5.22) equals

$$\begin{aligned} & \iint_{Q_t} \frac{\partial}{\partial \tau} |v_\tau(x+h, \tau) - v_\tau(x, \tau)| \zeta(x) \, dx \, d\tau \\ & = \int_{\Omega} |v(x+h, t) - v(x, t)| \zeta(x) \, dx - \int_{\Omega} |v_0(x+h) - v_0(x)| \zeta(x) \, dx. \end{aligned}$$

The second integral in (5.22) equals

$$\begin{aligned} & \iint_{Q_t} D|\vartheta(v(x+h, \tau)) - \vartheta(v(x, \tau))| \cdot D\zeta \, dx \, d\tau \\ & = - \iint_{Q_t} |\vartheta(v(x+h, \tau)) - \vartheta(v(x, \tau))| \Delta \zeta \, dx \, d\tau, \end{aligned}$$

so that, according to (5.17), its absolute value is majorised by

$$\frac{\gamma}{\delta^2} \iint_{\Omega_\delta \times (0, t)} |\vartheta(v(x+h, \tau)) - \vartheta(v(x, \tau))| \, dx \, d\tau \leq \frac{C}{\delta^2} |h|.$$

The third and last integral in (5.22) is bounded simply by taking into account the Lipschitz continuity of f . Collecting these estimates we find

$$\begin{aligned} & \int_{\Omega} |v(x+h, t) - v(x, t)| \zeta(x) \, dx \leq \int_{\Omega} |v_0(x+h) - v_0(x)| \zeta(x) \, dx \\ & + \frac{C}{\delta^2} |h| + \mu \int_0^t \int_{\Omega} |v(x+h, \tau) - v(x, \tau)| \zeta(x) \, dx \, d\tau. \end{aligned} \quad (5.23)$$

By Gronwall's lemma we conclude that

$$\begin{aligned} & \int_{\Omega} |v(x+h, t) - v(x, t)| \zeta(x) \, dx \leq \\ & e^{\mu t} \left\{ \int_{\Omega} |v_0(x+h) - v_0(x)| \zeta(x) \, dx + \frac{C}{\delta^2} |h| \right\} \end{aligned} \quad (5.24)$$

Assume now that the original initial data v_0 satisfies for all $h \in \mathbf{R}^N$, $|h| < \delta$, $\delta > 0$,

$$\int_{\Omega_\delta} |v_0(x+h) - v_0(x)| \, dx \leq C_\delta |h|. \quad (5.25)$$

We may therefore assume the approximating initial data v_{0n} satisfy a similar inequality (see Lemma 1.1 of Appendix B). This and (5.24) allow us to conclude that for all $0 < t < T$, $h \in \mathbf{R}^N$, $n \geq 1$,

$$\int_{\Omega_\delta} |v_n(x+h, t) - v_n(x, t)| \, dx \leq C_\delta |h|. \quad (5.26)$$

Standard (and trivial) results in functional analysis imply that (5.26) is equivalent, since $v_n \in C^\infty(\overline{Q_T})$, to

$$\int_{\Omega_\delta} |Dv_n(x, t)| \, dx \leq C_\delta. \quad (5.27)$$

Here and above, C_δ denotes a constant depending on δ , but not on n .

REMARK 5.1. In general, the L^1 estimate (5.26) does not imply for an integrable function v the existence of the gradient Dv in the sense of Sobolev. This is a marked difference with the case of similar L^p estimates, with $p > 1$. Instead, estimates like (5.26) imply that v is a function of *bounded variation*, or *BV* function, whence the title of this subsection.

5.3. Compactness of v_n in L^1 . In order to obtain the desired compactness of the sequence $\{v_n\}$, in $L^1_{\text{loc}}(Q_T)$, we still have to complement (5.26) with a similar estimate involving translations in *time* rather than in *space*. This bound will be achieved as a consequence of a theorem by Kruzhkov, which we state and prove in Appendix B. Essentially, the result states that if we already know some regularity of the solution to a parabolic equation at each time level, we may infer some (lesser) regularity in the time variable. The regularity in space is in our case guaranteed by (5.26). The remarkable input of the theorem is that strong continuity in an integral norm is a consequence of a notion of weak continuity. Let $g = g(x)$, $g \in C^1_0(\Omega_\delta)$. On multiplying (5.6) by g and integrating over Ω between t and $t+s$, $0 < t < t+s < T$, standard calculations give

$$\begin{aligned} \int_{\Omega} g(x)[v_n(x, t+s) - v_n(x, t)] \, dx &= - \int_t^{t+s} \int_{\Omega} Dg \cdot D\vartheta_n(v_n) \, dx \, d\tau \\ &\quad + \int_t^{t+s} \int_{\Omega} f(v_n)\eta_n g \, dx \, d\tau. \end{aligned} \quad (5.28)$$

Note that

$$\begin{aligned} \left| \int_t^{t+s} \int_{\Omega} Dg \cdot D\vartheta_n(v_n) \, dx \, d\tau \right| &\leq \int_t^{t+s} \int_{\Omega} \vartheta'_n(v_n) |Dg| |Dv_n| \, dx \, d\tau \\ &\leq \|\vartheta'_n\|_{\infty} \|Dg\|_{\infty} s \sup_{t < \tau < t+s} \int_{\Omega_{\delta}} |Dv_n(x, \tau)| \, dx \leq C_{\delta} \|Dg\|_{\infty} s, \end{aligned}$$

owing to estimate (5.27). Clearly C_{δ} does not depend on n . Therefore

$$\left| \int_{\Omega} g(x) [v_n(x, t+s) - v_n(x, t)] \, dx \right| \leq C_{\delta} (\|g\|_{\infty} + \|Dg\|_{\infty}) s, \quad (5.29)$$

for all $g \in C_0^1(\Omega_{\delta})$. Then, Kruzhkov's Theorem 2.1 of Appendix B (see also Remark 2.1 there) implies that

$$\int_{\Omega_{\delta}} |v_n(x, t+s) - v_n(x, t)| \, dx \leq C_{\delta} \sqrt{s}, \quad 0 < s < \delta^2, \quad (5.30)$$

for all $0 < t < t+s < T$, and for all $\delta > 0$. Combining (5.30) with (5.26) we obtain that the sequence $\{v_n\}$ is pre-compact in $L^1(\Omega_{\delta} \times (0, T))$. By means of usual diagonal procedures, we may extract a subsequence (still labelled by n) such that

$$v_n \rightarrow v, \quad \text{a.e. in } Q_T. \quad (5.31)$$

It follows

$$u_n = \vartheta_n(v_n) \rightarrow \vartheta(v) = u, \quad \text{a.e. in } Q_T, \quad (5.32)$$

where clearly u must equal the weak limit in (5.12).

For any testing function φ as in Definition 3.1, we may therefore take the limit $n \rightarrow \infty$ in (5.16), and obtain (3.7). By construction, v and u satisfy the relevant regularity requirements. By the same token, $\vartheta(v) = u$, i.e., $v \in E(u)$.

5.4. Removing the extra assumption on v_0 . We have so far proven existence of solutions under the extra regularity assumption (5.25), which is certainly satisfied, for example, if the initial data are in $C^1(\overline{\Omega})$. To extend the proof to the case when v_0 is merely assumed to be a bounded function (so that (5.25) does not necessarily hold), consider first a sequence of smoothed initial data $v_0^j \in C^1(\overline{\Omega})$, such that

$$v_0^j \rightarrow v_0, \quad \text{in } L^1(\Omega), \quad \|v_0^j\|_{\infty} \leq \|v_0\|_{\infty}. \quad (5.33)$$

Consider the sequence v^j of weak solutions, corresponding to these initial data, *to the Stefan problem*. These are therefore solutions in the sense of Definition 3.1. Note that, perhaps extracting a subsequence we may still assume that v^j , $u^j = \vartheta(v^j)$, Du^j converge weakly, because estimates (5.10), (5.11) are in force for them, uniformly on j .

Due to Theorem 4.1, and to (5.33), the sequence v^j actually is a Cauchy sequence in $L^1(Q_T)$. Again, perhaps extracting a subsequence we may assume that

$$v^j \rightarrow v, \quad \text{a.e. in } Q_T. \quad (5.34)$$

Hence, we may take the limit in the integral equation satisfied by v^j , i.e.,

$$\iint_{Q_T} \{-v^j \varphi_t + Du^j \cdot D\varphi\} dx dt = \int_{\Omega} v_0^j(x) \varphi(x, 0) dx + \iint_{Q_T} f(v^j) \varphi dx dt,$$

finally proving that v solves the original Stefan problem.

5.5. Exercises.

5.1. Prove in detail that (5.14) follows from (5.11).

5.2. A much simpler proof of existence of weak solutions is available when f does not depend on v (but, e.g., on u). In this case, indeed it is enough to prove strong convergence for the sequence u_n . To obtain the needed compactness estimate, which actually amounts to a bound of $\|u_{nt}\|_2$ uniform in n , multiply (5.9) by u_{nt} , and use the properties of E_n . Go over the details of this approach; e.g., prove that the weak limit v of v_n is an admissible enthalpy for the strong limit u of u_n .

5.3. Assume that (5.25) is replaced by

$$\int_{\Omega_\delta} |v_0(x+h) - v_0(x)| dx \leq C_\delta \omega(|h|),$$

for a non decreasing non negative continuous function $\omega : \mathbf{R} \rightarrow \mathbf{R}$, $\omega(0) = 0$, such that $\omega(s) \geq s$, $0 < s < 1$. Prove that the solution v satisfies for $|h| < \delta < 1$,

$$\int_{\Omega_\delta} |v(x+h, t) - v(x, t)| dx \leq C_\delta \omega(|h|), \quad \text{a.e. } t \in (0, T).$$

6. A comparison result

THEOREM 6.1. *Let $v_0^1, v_0^2 \in L^\infty(\Omega)$, and $f^1, f^2 \in C^\infty(\mathbf{R})$ satisfy (3.5). Denote by v^1, v^2 the corresponding weak solutions to the Stefan problem. If $v_0^1 \geq v_0^2$ in Ω , and $f^1 \geq f^2$ in \mathbf{R} , then $v^1 \geq v^2$ in Q_T .*

PROOF. As we already know a result of uniqueness of the solution, we may prove the statement by approximation. By the same token, we may assume the initial data are smooth, e.g., in $C^1(\overline{\Omega})$. Let

$$\{v_n^i\}_{n=1}^\infty, \quad i = 1, 2,$$

be the two sequences constructed in Section 5 as solutions to the problems (5.6)–(5.8), with v_{0n} [f] replaced with v_{0n}^i [f^i] respectively.

Subtract from each other the PDE solved by v_n^1 and v_n^2 , and multiply the resulting equation by

$$\varphi_\varepsilon = \text{sign}_\varepsilon^+(\vartheta_n(v_n^2) - \vartheta_n(v_n^1)),$$

where $\text{sign}_\varepsilon^+$ is a smooth approximation of the function $\text{sign}^+(s) = \chi_{(0, +\infty)}(s)$, with $\text{sign}_\varepsilon^{+'} \geq 0$. Integrating by parts over Q_t we obtain

$$\begin{aligned} \iint_{Q_t} [(v_{n\tau}^2 - v_{n\tau}^1) \varphi_\varepsilon + \text{sign}_\varepsilon^{+'}(u_n^2 - u_n^1) |D(u_n^2 - u_n^1)|^2] dx d\tau \\ = \iint_{Q_t} [f^2(v_n^2) - f^1(v_n^1)] \eta_n \varphi_\varepsilon dx d\tau. \end{aligned}$$

On dropping the quadratic term above, and letting $\varepsilon \rightarrow 0$ we get (recall that $\text{sign}^+(u_n^2 - u_n^1) = \text{sign}^+(v_n^2 - v_n^1)$, see the discussion in Subsection 5.2)

$$\int_{\Omega} (v_n^2 - v_n^1)_+(x, t) \, dx \leq \iint_{Q_t} [f^2(v_n^2) - f^1(v_n^1)] \eta_n \text{sign}^+(v_n^2 - v_n^1) \, dx \, d\tau.$$

We have performed an integration in time, and used $v_{0n}^1 \geq v_{0n}^2$. But, since $f^1 \geq f^2$,

$$\begin{aligned} [f^2(v_n^2) - f^1(v_n^1)] \text{sign}^+(v_n^2 - v_n^1) &= [f^2(v_n^2) - f^2(v_n^1)] \text{sign}^+(v_n^2 - v_n^1) \\ &\quad + [f^2(v_n^1) - f^1(v_n^1)] \text{sign}^+(v_n^2 - v_n^1) \leq \mu (v_n^2 - v_n^1)_+. \end{aligned}$$

Therefore

$$\int_{\Omega} (v_n^2 - v_n^1)_+(x, t) \, dx \leq \mu \iint_{Q_t} (v_n^2 - v_n^1)_+ \, dx \, d\tau.$$

Finally, an application of Gronwall's lemma concludes the proof. \square

APPENDIX A

Maximum principles for parabolic equations

1. The weak maximum principle

Let Q_T be a bounded open set of \mathbf{R}^{N+1} , contained in $\mathbf{R}^N \times (0, T)$, where $T > 0$.

DEFINITION 1.1. We denote by Q_T^* the parabolic interior of Q_T , that is the set of all points (\bar{x}, \bar{t}) with the property

$$\exists \varepsilon > 0 : B_\varepsilon(\bar{x}, \bar{t}) \cap \{t < \bar{t}\} \subset Q_T.$$

Here $B_\varepsilon(\bar{x}, \bar{t})$ denotes the $(N+1)$ -dimensional ball with radius ε and center (\bar{x}, \bar{t}) . Define also the parabolic boundary $\partial_p Q_T$ of Q_T , as

$$\partial_p Q_T = \overline{Q_T} - Q_T^*.$$

The set $\partial_p Q_T$ is the parabolic analogue of the boundary of Q_T , i.e., roughly speaking, the region where initial and boundary data should be prescribed for parabolic problems set in Q_T (see Figure 1).

For example, if $Q_T = (0, L) \times (0, T)$ then $Q_T^* = (0, L) \times (0, T]$.

Obviously we have $Q_T \subset Q_T^* \subset \overline{Q_T}$. In general $\partial_p Q_T$ is not a closed set.

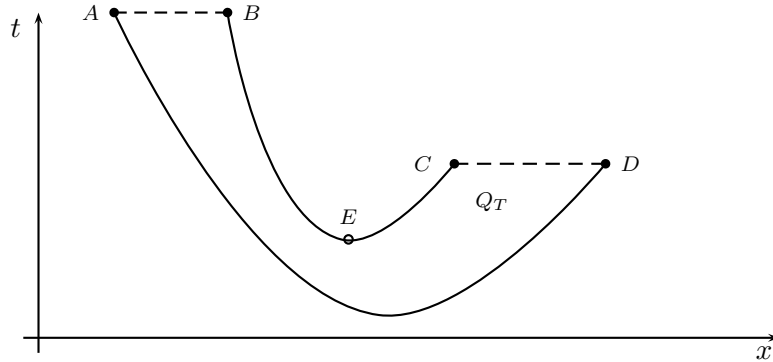

FIGURE 1. The dashed lines and the point E belong to the parabolic interior, but the points A, B, C, D , as well as the solid lines, belong to the parabolic boundary.

In the following we denote

$$\begin{aligned} \mathcal{L}u &= u_t - a_{ij}(x, t)u_{x_i x_j} + b_i(x, t)u_{x_i} + c(x, t)u, \\ \mathcal{L}_0 u &= u_t - a_{ij}(x, t)u_{x_i x_j} + b_i(x, t)u_{x_i}. \end{aligned}$$

Throughout this Appendix we employ the summation convention, and assume that

$$\begin{aligned} u &\in C^{2,1}(Q_T^*) \cap C(\overline{Q_T}), \quad a_{ij}, b_i, c \in C(Q_T^*); \\ a_{ij}(x, t)\xi_i\xi_j &\geq \nu|\xi|^2, \quad \text{for all } \xi \in \mathbf{R}^N, (x, t) \in Q_T^*. \end{aligned}$$

Here $\nu > 0$ is a given constant. We also assume

$$\sum_{i,j=1}^N \|a_{ij}\|_\infty =: A < \infty, \quad \sum_{i=1}^N \|b_i\|_\infty =: B < \infty, \quad \|c\|_\infty =: C < \infty.$$

LEMMA 1.1. *Assume that $\mathcal{L}_0 u(\bar{x}, \bar{t}) < 0$, where $(\bar{x}, \bar{t}) \in Q_T^*$. Then u can not attain a local maximum at (\bar{x}, \bar{t}) .*

PROOF. Recalling the definition of Q_T^* , we have, reasoning by contradiction,

$$\begin{aligned} \mathcal{L}_0 u(\bar{x}, \bar{t}) &= u_t(\bar{x}, \bar{t}) - a_{ij}(\bar{x}, \bar{t})u_{x_i x_j}(\bar{x}, \bar{t}) + b_i(\bar{x}, \bar{t})u_{x_i}(\bar{x}, \bar{t}) \\ &= u_t(\bar{x}, \bar{t}) - a_{ij}(\bar{x}, \bar{t})u_{x_i x_j}(\bar{x}, \bar{t}). \end{aligned}$$

Note that, if (\bar{x}, \bar{t}) is a point of local maximum, then $u_t(\bar{x}, \bar{t}) \geq 0$. By the same token, $a_{ij}u_{x_i x_j} \leq 0$ at (\bar{x}, \bar{t}) , as we show below. This leads of course to an inconsistency, as $\mathcal{L}_0 u(\bar{x}, \bar{t}) < 0$ by assumption.

To prove the assertion $a_{ij}u_{x_i x_j} \leq 0$ at (\bar{x}, \bar{t}) , we change spatial coordinates defining $y = \bar{x} + \Gamma(x - \bar{x})$, and $v(y, t) = u(x(y), t)$, where $\Gamma = (\gamma_{ij})$ is an $N \times N$ matrix such that $\Gamma(a_{ij}(\bar{x}, \bar{t}))\Gamma^t$ coincides with the diagonal matrix $\text{diag}(\lambda_1, \dots, \lambda_N)$ (we may assume without loss of generality that (a_{ij}) is symmetric). Then

$$a_{ij}u_{x_i x_j} = a_{ij}v_{y_h y_k} \gamma_{hi} \gamma_{kj} = \lambda_h v_{y_h y_h}, \quad \text{at } (\bar{x}, \bar{t}).$$

Note that $v(\cdot, \bar{t})$ attains a local maximum at $y = \bar{x}$, so that $v_{y_h y_h} \leq 0$ for all h . We also take into account that $\lambda_h > 0$ for all h , since (a_{ij}) is positive definite. The result immediately follows. \square

THEOREM 1.1. (WEAK MAXIMUM PRINCIPLE) *Let $\mathcal{L}_0 u \leq 0$ in Q_T^* . Then*

$$\max_{Q_T} u = \sup_{\partial_p Q_T} u. \quad (1.1)$$

PROOF. Let us define

$$v = (u - M)e^{-\varepsilon t}, \quad M = \sup_{\partial_p Q_T} u, \quad \varepsilon > 0.$$

If $u - M$ is positive at some $(x, t) \in Q_T^*$, then v attains a positive maximum somewhere in Q_T^* , say at (\bar{x}, \bar{t}) . Indeed $v \leq 0$ on $\partial_p Q_T$. We calculate

$$v_t = u_t e^{-\varepsilon t} - \varepsilon v, \quad v_{x_i} = u_{x_i} e^{-\varepsilon t}, \quad v_{x_i x_j} = u_{x_i x_j} e^{-\varepsilon t}.$$

Therefore

$$\mathcal{L}_0 v(\bar{x}, \bar{t}) = e^{-\varepsilon \bar{t}} \mathcal{L}_0 u(\bar{x}, \bar{t}) - \varepsilon v(\bar{x}, \bar{t}) \leq -\varepsilon v(\bar{x}, \bar{t}) < 0.$$

Upon recalling Lemma 1.1, this inconsistency concludes the proof. \square

1.1. More general operators. Let us consider here more general operators of the form \mathcal{L} .

THEOREM 1.2. *Let $\mathcal{L}u \leq f$ in Q_T^* , $f \in C(\overline{Q_T})$. Define*

$$\int_0^t \|f_+(\cdot, \tau)\|_\infty d\tau =: H(t), \quad 0 < t < T. \quad (1.2)$$

Then

$$\max_{\overline{Q_T}} u_+ \leq e^{C_- T} \left(\sup_{\partial_p Q_T} u_+ + H(T) \right), \quad (1.3)$$

where $C_- = \|c_-\|_{\infty, Q_T}$.

PROOF. Define for a constant $\gamma > 0$ to be chosen

$$w(x, t) = e^{-\gamma t} u(x, t) - m - H(t),$$

where

$$m := \sup_{\partial_p Q_T} u_+.$$

By definition of m , and since $\gamma > 0$, we have $w \leq 0$ on $\partial_p Q_T$. Moreover

$$\begin{aligned} \mathcal{L}_0 w &= e^{-\gamma t} \mathcal{L}_0 u - \gamma e^{-\gamma t} u - \|f_+(\cdot, t)\|_\infty \\ &\leq -c e^{-\gamma t} u + e^{-\gamma t} f_+(x, t) - \gamma e^{-\gamma t} u - \|f_+(\cdot, t)\|_\infty \leq -[c + \gamma] e^{-\gamma t} u. \end{aligned}$$

Therefore we have $\mathcal{L}_0 w < 0$ where $w > 0$ (and hence $u > 0$ too), provided we select $\gamma = C_- + \varepsilon$ for any arbitrarily fixed $\varepsilon > 0$. Thus, if w attains a positive maximum in Q_T^* , we arrive at an inconsistency with Lemma 1.1. We conclude that $w \leq 0$ in Q_T , and we recover (1.3) on letting $\varepsilon \rightarrow 0$. \square

Note that according to our theorem above, if $u \leq 0$ on $\partial_p Q_T$, and $f \leq 0$ in Q_T , then $u \leq 0$ in Q_T , regardless of the sign of c .

REMARK 1.1. All the results of this section still hold if the parabolicity constant ν is equal to 0. This is not the case for the results in next two sections. See also Section 4.

2. The strong maximum principle

Let $(\bar{x}, \bar{t}) \in Q_T^*$. Define the set $\mathcal{S}(\bar{x}, \bar{t})$ as the set of all $(x, t) \in Q_T$ with the property

(x, t) can be connected to (\bar{x}, \bar{t}) by a polygonal contained in Q_T , along which t is increasing, when going from (x, t) to (\bar{x}, \bar{t}) .

A *polygonal* is a connected curve made of a finite number of straight line segments. Essentially, the strong maximum principle asserts that if $\mathcal{L}_0 u \leq 0$ in Q_T , and u attains its maximum at a point (\bar{x}, \bar{t}) of Q_T^* , then u is constant in $\mathcal{S}(\bar{x}, \bar{t})$. Our first result is a weaker version of this principle.

The proof we present here was taken from [2]¹. The strong maximum principle for parabolic equations was first proven in [13].

¹The author of [2] quotes a course of D. Aronson (Minneapolis) as source of the proof.

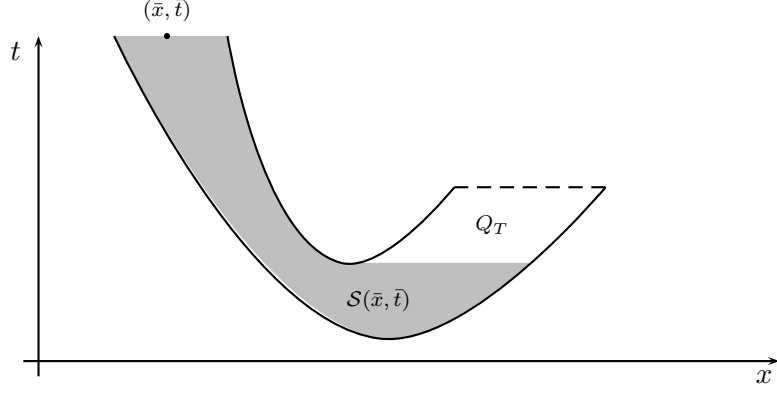
FIGURE 2. The set $\mathcal{S}(\bar{x}, \bar{t})$ as defined in the text.

LEMMA 2.1. *Let $\mathcal{L}_0 v \leq 0$ in $P_T = B_\delta(0) \times (0, T)$, $v \in C^{2,1}(P_T^*) \cap C(\overline{P_T})$, where $\delta > 0$, $T > 0$ and we assume*

$$v(x, t) \leq M, \quad |x| = \delta, \quad 0 < t < T, \quad (2.1)$$

$$v(x, 0) < M, \quad |x| \leq \delta, \quad (2.2)$$

for a given constant M . Then

$$v(x, T) < M, \quad |x| < \delta. \quad (2.3)$$

PROOF. We have by continuity

$$v(x, 0) < M - \varepsilon \delta^4, \quad |x| \leq \delta, \quad (2.4)$$

for a suitable $\varepsilon > 0$, which we fix from now on subject to this constraint.

Let us define, for a $\alpha > 0$ to be chosen,

$$w(x, t) = M - \varepsilon(\delta^2 - |x|^2)^2 e^{-\alpha t} - v(x, t).$$

Then

$$\begin{aligned} \mathcal{L}_0 w(x, t) &= -\mathcal{L}_0[\varepsilon(\delta^2 - |x|^2)^2 e^{-\alpha t}] - \mathcal{L}_0 v(x, t) \\ &\geq -\mathcal{L}_0[\varepsilon(\delta^2 - |x|^2)^2 e^{-\alpha t}] = e^{-\alpha t} \left\{ \varepsilon \alpha (\delta^2 - |x|^2)^2 \right. \\ &\quad \left. - 4\varepsilon(\delta^2 - |x|^2) a_{jj} + 8\varepsilon a_{ij} x_i x_j - 4\varepsilon b_i x_i (\delta^2 - |x|^2) \right\}. \end{aligned} \quad (2.5)$$

Here we employ the summation convention even for the term a_{jj} and we understand the coefficient a_{ij} , b_i to be calculated at (x, t) . We aim at proving that the quantity $\{\dots\}$ in last formula above is non negative, for a suitable choice of $\alpha > 0$. Introduce a parameter $\tau \in (0, 1)$, and distinguish the cases:

(i) If $|x| \leq \tau \delta$, then

$$\{\dots\} \geq \varepsilon(\delta^2 - |x|^2) [\alpha \delta^2 (1 - \tau^2) - 4A - 4B\tau \delta] \geq 0,$$

provided

$$\alpha \delta^2 (1 - \tau^2) - 4A - 4B\tau \delta \geq 0. \quad (2.6)$$

(ii) If $\delta > |x| > \tau\delta$, then

$$\begin{aligned} \{\dots\} &\geq \varepsilon[-4A\delta^2(1-\tau^2) + 8\nu|x|^2 - 4B\delta^3(1-\tau^2)] \\ &\geq 4\varepsilon[-A\delta^2(1-\tau^2) + 2\nu\tau^2\delta^2 - B\delta^3(1-\tau^2)] \\ &= 4\varepsilon\delta^2[2\nu\tau^2 - A(1-\tau^2) - B\delta(1-\tau^2)] \geq 0, \end{aligned}$$

provided

$$2\nu\tau^2 - A(1-\tau^2) - B\delta(1-\tau^2) \geq 0. \quad (2.7)$$

We may first select τ so as (2.7) is satisfied, and then choose α so that (2.6) is satisfied too. Having fixed in this fashion the values of τ and α , we proceed to observe that

$$\mathcal{L}_0 w \geq 0, \quad \text{in } P_T.$$

Moreover on the parabolic boundary of P_T we have

$$\begin{aligned} w(x, t) &= M - v(x, t) \geq 0, & \text{on } |x| = \delta; \\ w(x, 0) &= M - \varepsilon(\delta^2 - |x|^2)^2 - v(x, 0) \\ &\geq M - \varepsilon\delta^4 - v(x, 0) \geq 0, & \text{in } |x| \leq \delta; \end{aligned}$$

we have made use of (2.4). Therefore $w \geq 0$ in P_T owing to the weak maximum principle.

Especially

$$w(x, T) = M - \varepsilon(\delta^2 - |x|^2)^2 e^{-\alpha T} - v(x, T) \geq 0,$$

and we finally prove our claim, i.e., for $|x| < \delta$,

$$v(x, T) \leq M - \varepsilon(\delta^2 - |x|^2)^2 e^{-\alpha T} < M.$$

□

THEOREM 2.1. (STRONG MAXIMUM PRINCIPLE) *Let $\mathcal{L}_0 u \leq 0$ in Q_T^* . If $(\bar{x}, \bar{t}) \in Q_T^*$, and*

$$\max_{\overline{Q_T}} u = u(\bar{x}, \bar{t}),$$

then

$$u(x, t) = u(\bar{x}, \bar{t}), \quad \text{for all } (x, t) \in \mathcal{S}(\bar{x}, \bar{t}). \quad (2.8)$$

PROOF. Let us proceed by contradiction. Assume a point $(x_1, t_1) \in \mathcal{S}(\bar{x}, \bar{t})$ exists such that $u(x_1, t_1) < u(\bar{x}, \bar{t}) =: M$, and consider a polygonal (which must exist by definition of $\mathcal{S}(\bar{x}, \bar{t})$)

$$\cup_{i=1}^n \{(1-\lambda)(x_i, t_i) + \lambda(x_{i+1}, t_{i+1}) \mid \lambda \in [0, 1]\},$$

where $(x_{n+1}, t_{n+1}) = (\bar{x}, \bar{t})$, and $t_i < t_{i+1}$, for $i = 1, \dots, n$. We are going to prove that

$$u(x_i, t_i) < M \implies u(x_{i+1}, t_{i+1}) < M,$$

which obviously leads us to the contradiction

$$u(\bar{x}, \bar{t}) = u(x_{n+1}, t_{n+1}) < M = u(\bar{x}, \bar{t}).$$

We may assume without loss of generality $i = 1$, $i + 1 = 2$. Let us switch to different space coordinates:

$$\xi^j = x^j - x_1^j - (x_2^j - x_1^j) \frac{t - t_1}{t_2 - t_1}, \quad j = 1, \dots, N.$$

Thus

$$(x_1, t_1) \mapsto (0, t_1), \quad (x_2, t_2) \mapsto (0, t_2).$$

Also define the function

$$v(\xi, t) = u(x(\xi, t), t).$$

In the change to the new variables, the set Q_T is transformed to an open set which certainly contains the closure of the cylinder

$$E_\delta = \{(\xi, t) \mid |\xi| < \delta, t_1 < t < t_2\},$$

provided $\delta > 0$ is suitably chosen. Possibly redefining δ we may assume (by continuity)

$$v(\xi, t_1) < M, \quad |\xi| \leq \delta,$$

From now on, let δ be fixed in this way.

We have in E_δ

$$\tilde{\mathcal{L}}_0 v(\xi, t) := v_t(\xi, t) - a_{ij}(x(\xi, t), t) v_{\xi_i \xi_j}(\xi, t) + \tilde{b}_i(\xi, t) v_{\xi_i}(\xi, t) \leq 0. \quad (2.9)$$

where

$$\tilde{b}_i(\xi, t) = b_i(x(\xi, t), t) - \frac{x_2^i - x_1^i}{t_2 - t_1}.$$

Note that $\tilde{\mathcal{L}}_0$ is an operator satisfying the same assumptions as \mathcal{L}_0 . More specifically

$$\sum_{i=1}^n \|\tilde{b}_i\|_\infty \leq \tilde{B} := B + N \frac{|x_2 - x_1|}{(t_2 - t_1)}.$$

Finally,

$$v(\xi, t) \leq M, \quad |\xi| = \delta, t_1 < t < t_2,$$

follows from the definition of M . Therefore we may apply Lemma 2.1 to conclude that

$$u(x_2, t_2) = v(0, t_2) < M,$$

as claimed. \square

2.1. More general operators. Lemma 2.1 and Theorem 2.1 still hold, if \mathcal{L}_0 in their statements is replaced with the more general operator \mathcal{L} , provided $c(x, t)M \geq 0$ in Q_T (here $M = u(\bar{x}, \bar{t})$ in Theorem 2.1).

We sketch here the changes needed in the proof of the Lemma, the proof of the Theorem being essentially the same:

The calculation in (2.5) should be replaced with

$$\begin{aligned} \tilde{\mathcal{L}}w(\xi, t) &= \tilde{\mathcal{L}}[M - \varepsilon(\delta^2 - |\xi|^2)^2 e^{-\alpha(t-t_1)}] - \tilde{\mathcal{L}}v(\xi, t) \\ &\geq cM - \tilde{\mathcal{L}}[\varepsilon(\delta^2 - |\xi|^2)^2 e^{-\alpha(t-t_1)}] \geq -C\varepsilon(\delta^2 - |\xi|^2)^2 e^{-\alpha(t-t_1)} + \mathcal{F} \\ &= e^{-\alpha(t-t_1)} \left\{ \varepsilon(\alpha - C)(\delta^2 - |\xi|^2)^2 \right. \\ &\quad \left. - 4\varepsilon(\delta^2 - |\xi|^2)a_{jj} + 8\varepsilon a_{ij}\xi_i \xi_j - [b_i - \frac{x_2^i - x_1^i}{t_2 - t_1}] 4\varepsilon \xi_i (\delta^2 - |\xi|^2) \right\}, \end{aligned}$$

where \mathcal{F} denotes the the last term in the chain of inequalities in (2.5). Here we used the fact that $cM \geq 0$. It is clear that, additionally assuming e.g., $\alpha > 2C$, the proof can be continued as above, taking into account Theorem 1.2.

3. Hopf's lemma (the boundary point principle)

DEFINITION 3.1. We say that a point $(\bar{x}, \bar{t}) \in \partial_p Q_T$ has the property of the spherical cap if there exists an open ball $B_r(x_0, t_0)$ such that

$$(\bar{x}, \bar{t}) \in \partial B_r(x_0, t_0), \quad B_r(x_0, t_0) \cap \{t < \bar{t}\} \subset Q_T,$$

with $x_0 \neq \bar{x}$.

In the following we denote by $C_r(\bar{x}, \bar{t})$ a cap $B_r(x_0, t_0) \cap \{t < \bar{t}\}$ as the one appearing in Definition 3.1. Note that if (\bar{x}, \bar{t}) has the property of the spherical cap, then there exist infinitely many such caps.

REMARK 3.1. If (\bar{x}, \bar{t}) has the property of the spherical cap, the N -dimensional open set $G := Q_T^* \cap \{t = \bar{t}\}$ has the usual property of the sphere at \bar{x} . Indeed, it contains the N -dimensional sphere $B_r(x_0, t_0) \cap \{t = \bar{t}\}$, which however touches the boundary of G at \bar{x} .

On the other hand, examples can be easily given where $(\bar{x}, \bar{t}) \in \partial_p Q_T$ has the property of the spherical cap, but fails to have the property of the sphere; see Figures 3 and 4.

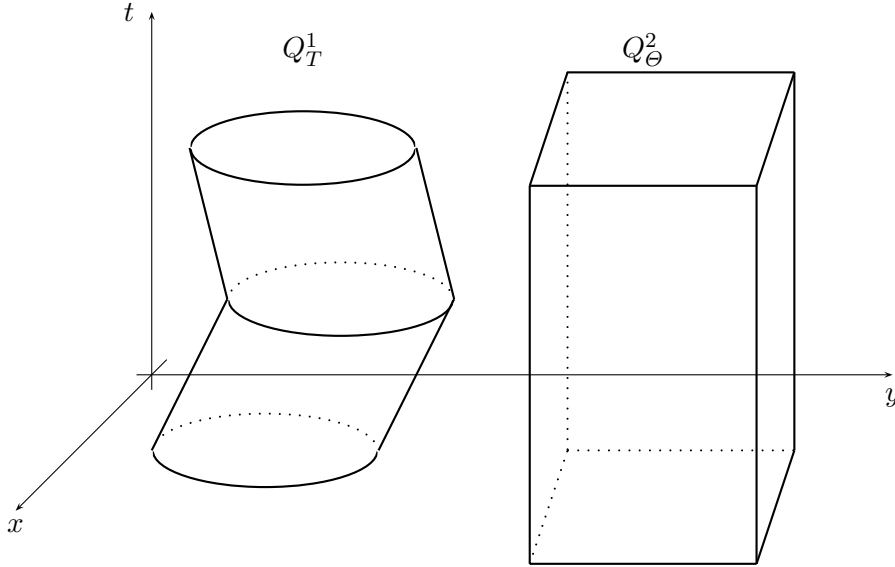

FIGURE 3. Every point of $\partial_p Q_T^1 \cap \{t > 0\}$ has the spherical cap property. This fails for the points on the vertical edges of Q_θ^2 .

A version of Hopf's lemma for parabolic equations was first proven in [19], [7].

THEOREM 3.1. (HOPF'S LEMMA) *Let $\mathcal{L}_0 u \leq 0$ in Q_T^* . Let $(\bar{x}, \bar{t}) \in \partial_p Q_T$ have the property of the spherical cap. If*

$$u(x, t) < u(\bar{x}, \bar{t}), \quad \text{for all } (x, t) \in C_r(\bar{x}, \bar{t}), \quad (3.1)$$

then

$$\frac{\partial u}{\partial \mathbf{e}}(\bar{x}, \bar{t}) < 0, \quad (3.2)$$

where $\mathbf{e} \in \mathbf{R}^{N+1}$ is any direction such that

$$(\bar{x}, \bar{t}) + s\mathbf{e} \in \overline{C_r(\bar{x}, \bar{t})}, \quad \text{for } 0 < s < \Sigma(\mathbf{e}), \quad (3.3)$$

and we also assume that the derivative in (3.2) exists.

PROOF. First, let us invoke the strong maximum principle to prove that the maximum value $u(\bar{x}, \bar{t})$ may not be attained in the parabolic interior of $C_r(\bar{x}, \bar{t})$. Namely, we obtain in this fashion the additional piece of information that

$$u(x, t) < u(\bar{x}, \bar{t}), \quad \text{for all } (x, t) \in B_r(x_0, t_0).$$

Then, for each fixed \mathbf{e} as in (3.3), we may find a spherical cap C' such that its closure $\overline{C'}$ is contained in $C_r(\bar{x}, \bar{t})^* \cup \{(\bar{x}, \bar{t})\}$ and

$$u(x, t) < u(\bar{x}, \bar{t}), \quad \text{for all } (x, t) \in \overline{C'}, (x, t) \neq (\bar{x}, \bar{t}), \quad (3.4)$$

$$(\bar{x}, \bar{t}) + s\mathbf{e} \in \overline{C'}, \quad \text{for } 0 < s < \Sigma'(\mathbf{e}). \quad (3.5)$$

We'll keep the notation $C_r(\bar{x}, \bar{t})$ in the following for a cap satisfying (3.4), (3.5). Let us consider the barrier function

$$w(x, t) = \exp\{-\alpha(|x - x_0|^2 + |t - t_0|^2)\} - \exp\{-\alpha r^2\},$$

where $\alpha > 0$ is to be chosen, and (x_0, t_0) , r are as in Definition 3.1. Thus $1 > w > 0$ in $B_r(x_0, t_0)$, $w = 0$ on $\partial B_r(x_0, t_0)$, and

$$w_t(x, t) = -2(t - t_0)\alpha \exp\{-\alpha(|x - x_0|^2 + |t - t_0|^2)\},$$

$$w_{x_i}(x, t) = -2(x^i - x_0^i)\alpha \exp\{-\alpha(|x - x_0|^2 + |t - t_0|^2)\},$$

$$w_{x_i x_j}(x, t) = (-2\delta_{ij}\alpha + 4(x^i - x_0^i)(x^j - x_0^j)\alpha^2) \exp\{\dots\}.$$

Therefore we have

$$\begin{aligned} \mathcal{L}_0 w(x, t) &= 2\alpha \exp\{\dots\} [-(t - t_0) + a_{ii} - 2\alpha a_{ij}(x^i - x_0^i)(x^j - x_0^j) - b_i(x^i - x_0^i)] \\ &\leq 2\alpha \exp\{\dots\} [(t_0 - t) + A - 2\alpha\nu|x - x_0|^2 + B|x - x_0|]. \end{aligned} \quad (3.6)$$

Define

$$\Omega = C_r(\bar{x}, \bar{t}) \cap \{|x - \bar{x}| < \varepsilon\},$$

where the positive number ε is selected so as, for $(x, t) \in \Omega$,

$$|x - x_0| \geq |\bar{x} - x_0| - |x - \bar{x}| \geq r \sin \theta - \varepsilon \geq \frac{1}{2}r \sin \theta.$$

Here θ is the angle between the t axis and the straight line joining (x_0, t_0) , (\bar{x}, \bar{t}) . Note that $\theta \in (0, \pi/2]$ as a consequence of $x_0 \neq \bar{x}$, according to Definition 3.1; see also Figure 4. Hence, in Ω we have

$$\mathcal{L}_0 w(x, t) \leq 2\alpha \exp\{\dots\} [r + A - \frac{1}{2}\alpha\nu r^2 \sin^2 \theta + Br] \leq 0,$$

provided we finally choose α so that

$$\frac{2(A + r + Br)}{\nu r^2 \sin^2 \theta} \leq \alpha.$$

Define for a positive number μ to be chosen presently,

$$v(x, t) = u(x, t) + \mu w(x, t), \quad (x, t) \in \Omega.$$

Note that

$$\partial_p \Omega = S_1 \cup S_2, \quad S_1 \subset \partial B_r(x_0, t_0), \quad S_2 \subset \{|x - \bar{x}| = \varepsilon\} \cap \overline{C_r(\bar{x}, \bar{t})}.$$

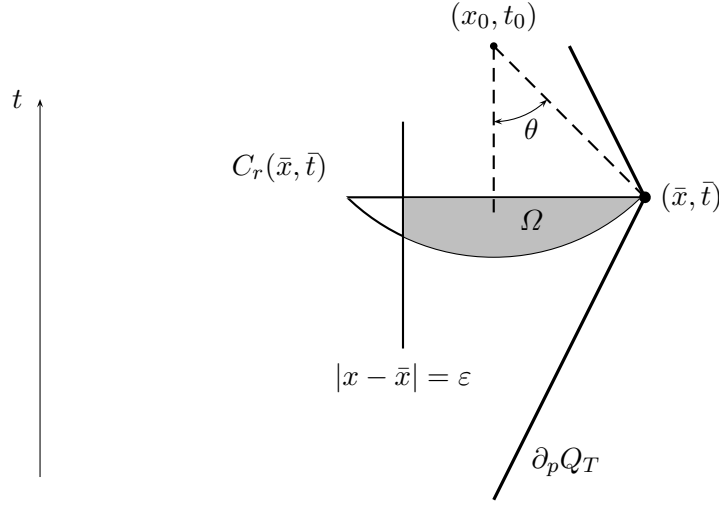
FIGURE 4. Ω and $C_r(\bar{x}, \bar{t})$, in the case $t_0 > \bar{t}$.

Then, on S_1 $w = 0$ and thus

$$v(x, t) = u(x, t) \leq u(\bar{x}, \bar{t}).$$

On S_2 , taking into account (3.4),

$$u(x, t) \leq u(\bar{x}, \bar{t}) - \sigma,$$

for a suitable $\sigma > 0$. It follows that on S_2 too

$$v(x, t) = u(x, t) + \mu w(x, t) \leq u(\bar{x}, \bar{t}) - \sigma + \mu \leq u(\bar{x}, \bar{t}),$$

if we choose $\mu \leq \sigma$. Moreover

$$\mathcal{L}_0 v = \mathcal{L}_0 u + \mu \mathcal{L}_0 w \leq \mathcal{L}_0 u \leq 0, \quad \text{in } \Omega.$$

The weak maximum principle yields

$$v(x, t) \leq u(\bar{x}, \bar{t}), \quad \text{in } \Omega.$$

On the other hand, $v(\bar{x}, \bar{t}) = u(\bar{x}, \bar{t})$, so that

$$\frac{\partial v}{\partial \mathbf{e}}(\bar{x}, \bar{t}) \leq 0.$$

Therefore

$$\frac{\partial u}{\partial \mathbf{e}}(\bar{x}, \bar{t}) = \frac{\partial v}{\partial \mathbf{e}}(\bar{x}, \bar{t}) - \mu \frac{\partial w}{\partial \mathbf{e}}(\bar{x}, \bar{t}) \leq 2\mu\alpha(\bar{x} - x_0, \bar{t} - t_0) \cdot \mathbf{e} \exp\{\dots\} < 0.$$

□

A typical application of Theorem 3.1 is the following: assume u satisfies $\mathcal{L}_0 u = 0$ in Q_T and attains its maximum at a point $(\bar{x}, \bar{t}) \in \partial_p Q_T$, having the spherical cap property. Unless u is identically constant in a portion of Q_T , by the strong maximum principle, u is strictly less than its maximum value in Q_T . Therefore we are in a position to apply Hopf's lemma, and prove $\frac{\partial u}{\partial \mathbf{n}} > 0$, if \mathbf{n} is the *spatial outer normal* to Q_T at (\bar{x}, \bar{t}) (as defined in Subsection 2.1 of Chapter 2).

3.1. More general operators. Theorem 3.1 still holds, if \mathcal{L}_0 in the statement is replaced with the more general operator \mathcal{L} , provided $c(x, t) \geq 0$ in Q_T , and $u(\bar{x}, \bar{t}) \geq 0$. We sketch here the changes needed in the proof:

The operator \mathcal{L}_0 is to be replaced everywhere with \mathcal{L} .

Estimate (3.6) is substituted with the relation

$$\begin{aligned} \mathcal{L}w(x, t) &\leq 2\alpha \exp\{\dots\} \left[\frac{c}{2\alpha} - (t-t_0) + a_{ii} - 2\alpha a_{ij}(x^i - x_0^i)(x^j - x_0^j) - b_i(x^i - x_0^i) \right] \\ &\leq 2\alpha \exp\{\dots\} \left[A + \frac{C}{2} - \frac{1}{2}\alpha\nu r^2 \sin^2 \theta + r + Br \right] \leq 0, \end{aligned}$$

which is valid in Ω as above, for a suitable selection of $\alpha > 1$. The proof is concluded as above.

3.2. Maximum estimates in problems with boundary conditions involving the spatial gradient. Assume u solves the problem, to be complemented with initial and additional boundary data,

$$\mathcal{L}_0 u = 0, \quad \text{in } G \times (0, T), \quad (3.7)$$

$$\frac{\partial u}{\partial \mathbf{n}} = 0, \quad \text{on } \Gamma \subset \partial G \times (0, T), \quad (3.8)$$

where $G \subset \mathbf{R}^N$, and \mathbf{n} denotes the outer spatial normal to $\partial G \times (0, T)$. Then u can not attain either its maximum or its minimum on Γ , owing to Hopf's lemma (unless it is identically constant in some open set).

Assume now (3.8) is replaced with

$$\frac{\partial u}{\partial \mathbf{n}} = -h(x, t)u + k(x, t), \quad \text{on } \Gamma \subset \partial G \times (0, T).$$

Here $h > 0$ and k are continuous functions. Assume $(\bar{x}, \bar{t}) \in \Gamma$ is a point of maximum for u . Then

$$0 < \frac{\partial u}{\partial \mathbf{n}}(\bar{x}, \bar{t}) = -h(\bar{x}, \bar{t})u(\bar{x}, \bar{t}) + k(\bar{x}, \bar{t}),$$

implying

$$u(\bar{x}, \bar{t}) < \frac{k(\bar{x}, \bar{t})}{h(\bar{x}, \bar{t})}.$$

Note however that a similar, but not necessarily strict, inequality can be proven trivially without invoking Hopf's lemma. Analogous estimates hold at points of minimum.

4. Maximum principle for weak solutions

In this section we proceed formally, with the purpose of exhibiting the ideas behind a possible extension of the maximum principle to weak solutions of

$$u_t - \operatorname{div} \mathbf{a}(x, t, u, Du) \leq 0, \quad \text{in } Q_T = G \times (0, T), \quad (4.1)$$

where

$$\mathbf{a}(x, t, u, Du) \cdot Du \geq 0.$$

Assume that $\partial G \times (0, T) = S_1 \cup S_2$, with

$$\begin{aligned} u(x, t) &\leq M, & \text{on } S_1, \\ \mathbf{a}(x, t, u, Du) \cdot \mathbf{n} &\leq 0, & \text{on } S_2, \end{aligned}$$

in a sense suitable for the calculations showed below, and also that

$$u(x, 0) \leq M, \quad x \in G.$$

Here \mathbf{n} is, as above, the outer spatial normal.

Multiply (formally) (4.1) by $(u - M)_+$, and integrate by parts, obtaining, on dropping the non negative term involving $\mathbf{a} \cdot Du$,

$$\begin{aligned} \int_G (u(x, t) - M)_+^2 dx &\leq 2 \int_0^t \int_{\partial G} (u - M)_+ \mathbf{a}(x, t, u, Du) \cdot \mathbf{n} d\sigma d\tau \\ &\quad + \int_G (u(x, 0) - M)_+^2 dx, \end{aligned}$$

for all $t \in (0, T)$. The last integral equals 0, because of the assumed bound on the initial data. The surface integral is non positive: indeed, on S_1 we have $(u - M)_+ = 0$, while on S_2 it holds

$$(u - M)_+ \mathbf{a}(x, t, u, Du) \cdot \mathbf{n} \leq 0.$$

Therefore we get

$$\int_G (u(x, t) - M)_+^2 dx \leq 0, \quad \text{for all } 0 < t < T,$$

i.e., $u \leq M$ in $G \times (0, T)$.

APPENDIX B

A theorem by Kruzhkov

We present here a result of [10], which is instrumental in our proof of existence of weak solutions to the Stefan problem, in the modified version quoted in [8].

1. Mollifying kernels

Let φ be a mollifying kernel, i.e.,

$$\varphi \in C_0^\infty(\mathbf{R}), \quad \text{supp } \varphi \subset [-1, 1], \quad \varphi \geq 0, \quad \varphi > 0 \quad \text{on } [-1/2, 1/2].$$

Define

$$\varphi_\varepsilon(x) = \frac{1}{\varepsilon^N} \varphi\left(\frac{|x|}{\varepsilon}\right), \quad x \in \mathbf{R}^N.$$

On multiplying, if required, φ by a positive constant, we may assume

$$\int_{\mathbf{R}^N} \varphi_\varepsilon(x) \, dx = \int_{\mathbf{R}^N} \varphi(|x|) \, dx = 1, \quad \text{for all } \varepsilon > 0.$$

Let $v \in L^1_{\text{loc}}(\mathbf{R}^N)$. Define for all $x \in \mathbf{R}^N$,

$$v_\varepsilon(x) = \int_{\mathbf{R}^N} v(y) \varphi_\varepsilon(x - y) \, dy = \int_{\mathbf{R}^N} v(x - z) \varphi_\varepsilon(z) \, dz. \quad (1.1)$$

Let Ω be a bounded open set of \mathbf{R}^N with a Lipschitz continuous boundary. Define for $1 > \delta > 0$

$$\Omega_\delta = \{x \in \Omega \mid \text{dist}(x, \partial\Omega) > \delta\}.$$

In the following ω_δ will denote a *modulus of continuity*, that is a continuous, non decreasing, non negative function $\omega_\delta : \mathbf{R} \rightarrow \mathbf{R}$ such that $\omega_\delta(0) = 0$. The notation emphasizes the possible dependence of this function on δ .

Our first result is not actually needed in the proof of the main estimate Theorem 2.1, but it was quoted in the proof of Theorem 5.1 of Chapter 2.

LEMMA 1.1. *Let $v \in L^1(\Omega)$, and assume that for each $0 < \delta < 1$, $h \in \mathbf{R}^N$, $|h| < \delta$*

$$\int_{\Omega_\delta} |v(x + h) - v(x)| \, dx \leq \omega_\delta(|h|). \quad (1.2)$$

Then, for all $0 < \varepsilon < \delta$, $|h| < \delta$,

$$\int_{\Omega_{2\delta}} |v_\varepsilon(x + h) - v_\varepsilon(x)| \, dx \leq \omega_\delta(|h|). \quad (1.3)$$

Note that, to keep our notation formally coherent with (1.1), we extend in (1.3) v to $v = 0$ outside of Ω . However, the integrals defining $v_\varepsilon(x + h)$ and $v_\varepsilon(x)$ there are actually calculated over Ω (check this).

PROOF. By definition of v_ε ,

$$\begin{aligned}
\int_{\Omega_{2\delta}} |v_\varepsilon(x+h) - v_\varepsilon(x)| \, dx &= \int_{\Omega_{2\delta}} \left| \int_{\mathbf{R}^N} v(y) [\varphi_\varepsilon(x+h-y) - \varphi_\varepsilon(x-y)] \, dy \right| \, dx \\
&= \int_{\Omega_{2\delta}} \left| \int_{\mathbf{R}^N} \varphi_\varepsilon(y) [v(x+h-y) - v(x-y)] \, dy \right| \, dx \\
&\leq \int_{\mathbf{R}^N} \varphi_\varepsilon(y) \left[\int_{\Omega_{2\delta}} |v(x+h-y) - v(x-y)| \, dx \right] \, dy \\
&= \int_{\mathbf{R}^N} \varphi_\varepsilon(y) \left[\int_{\Omega_{2\delta-y}} |v(z+h) - v(z)| \, dz \right] \, dy.
\end{aligned}$$

Here we use the standard notation

$$G - y = \{z \mid z + y \in G\}.$$

Recall that $\varphi_\varepsilon(y) = 0$ if $|y| \geq \varepsilon$. Therefore in last integral we may assume, as $\varepsilon < \delta$ by assumption,

$$\Omega_{2\delta} - y \subset \Omega_{2\delta-\varepsilon} \subset \Omega_\delta.$$

Hence the last integral above is bounded by

$$\int_{\mathbf{R}^N} \varphi_\varepsilon(y) \omega_\delta(|h|) \, dy \leq \omega_\delta(|h|).$$

□

Let us define the sign function

$$\text{sign}(s) = \begin{cases} 1, & s > 0, \\ 0, & s = 0, \\ -1, & s < 0. \end{cases}$$

Clearly, as $\varepsilon \rightarrow 0$,

$$v(x)[\text{sign}(v(x))]_\varepsilon \rightarrow v(x) \text{sign}(v(x)) = |v(x)|, \quad \text{a.e. } x \in \mathbf{R}^N.$$

Next lemma gives a measure of the speed of convergence in this limiting relation.

LEMMA 1.2. *In the same assumptions of Lemma 1.1, for all $0 < \varepsilon < \delta$,*

$$\int_{\Omega_\delta} ||v(x)| - v(x)[\text{sign}(v(x))]_\varepsilon| \, dx \leq 2\omega_\delta(\varepsilon). \quad (1.4)$$

PROOF. For all $x, y \in \mathbf{R}^N$

$$\begin{aligned}
||v(x)| - v(x) \text{sign}(v(y))| &= ||v(x)| - |v(y)|| - [v(x) - v(y)] \text{sign}(v(y))| \\
&\leq 2|v(x) - v(y)|.
\end{aligned}$$

Thus

$$\begin{aligned} & \int_{\Omega_\delta} \left| |v(x)| - v(x)[\text{sign}(v(x))]_\varepsilon \right| dx \\ &= \int_{\Omega_\delta} \left| \int_{\mathbf{R}^N} [|v(x)| - v(x) \text{sign}(v(y))] \varphi_\varepsilon(x-y) dy \right| dx \\ &\leq \int_{\Omega_\delta} \int_{\mathbf{R}^N} 2|v(x) - v(y)| \varphi_\varepsilon(x-y) dy dx = 2 \int_{\mathbf{R}^N} \int_{\Omega_\delta} |v(x) - v(x-y)| dx \varphi_\varepsilon(y) dy. \end{aligned}$$

Since $\varphi_\varepsilon(y) = 0$ for $|y| \geq \varepsilon$, we may bound above last integral by

$$2 \int_{\mathbf{R}^N} \int_{\Omega_\delta} |v(x) - v(x-y)| dx \varphi_\varepsilon(y) dy \leq 2 \int_{\mathbf{R}^N} \omega_\delta(|y|) \varphi_\varepsilon(y) dy \leq 2\omega_\delta(\varepsilon).$$

□

2. The main estimate

THEOREM 2.1. *Let $v \in L^\infty(Q_T)$, and assume that for all $1 > \delta > 0$, $|h| \leq \delta$ we have*

$$\int_{\Omega_\delta} |v(x+h, t) - v(x, t)| dx \leq \omega_\delta(|h|), \quad \text{a.e. } t \in (0, T). \quad (2.1)$$

Assume moreover that for all $g \in C_0^1(\Omega_\delta)$, and a given $C_\delta > 0$,

$$\left| \int_{\Omega_\delta} g(x) [v(x, t+s) - v(x, t)] dx \right| \leq C_\delta s (\|g\|_\infty + \|Dg\|_\infty), \quad (2.2)$$

a.e. $0 < t < t+s < T$. Then, we have a.e. $0 < t < t+s < T$, and for all $0 < \varepsilon < \delta$,

$$\int_{\Omega_\delta} |v(x, t+s) - v(x, t)| dx \leq \gamma_\delta \left(\frac{s}{\varepsilon} + \varepsilon + \omega_\delta(\varepsilon) \right). \quad (2.3)$$

Here γ_δ depends on Ω , C_δ , $\|v\|_\infty$ and N .

PROOF. Choose in (2.2)

$$g(x) = \beta_\varepsilon(x) = \int_{\mathbf{R}^N} \beta(y) \varphi_\varepsilon(x-y) dy,$$

where $0 < \varepsilon < \delta$ and

$$\beta(x) = \chi_{\Omega_{2\varepsilon+\delta}}(x) \text{sign}(v(x, t+s) - v(x, t)).$$

Note that

$$|Dg| \leq \frac{\gamma(N)}{\varepsilon};$$

moreover $g(x) = 0$ if $x \in \Omega_\delta - \Omega_{\varepsilon+\delta}$. Finally,

$$\beta_\varepsilon(x) = [\text{sign}(v(x, t+s) - v(x, t))]_\varepsilon, \quad x \in \Omega_{3\varepsilon+\delta}.$$

Thus, exploiting assumption (2.2),

$$\begin{aligned} \left| \int_{\Omega_{3\varepsilon+\delta}} [v(x, t+s) - v(x, t)] \beta_\varepsilon(x) \, dx \right| &\leq \left| \int_{\Omega_\delta} [v(x, t+s) - v(x, t)] \beta_\varepsilon(x) \, dx \right| \\ &+ \left| \int_{\Omega_\delta - \Omega_{3\varepsilon+\delta}} [v(x, t+s) - v(x, t)] \beta_\varepsilon(x) \, dx \right| \leq C_\delta \gamma(N) \frac{s}{\varepsilon} + \gamma(\Omega) \|v\|_\infty \varepsilon. \end{aligned}$$

Therefore

$$\begin{aligned} \int_{\Omega_\delta} |v(x, t+s) - v(x, t)| \, dx &\leq \int_{\Omega_{3\varepsilon+\delta}} |v(x, t+s) - v(x, t)| \, dx + \gamma(\Omega) \|v\|_\infty \varepsilon \\ &\leq \int_{\Omega_{3\varepsilon+\delta}} \left| |v(x, t+s) - v(x, t)| - [v(x, t+s) - v(x, t)] \beta_\varepsilon(x) \right| \, dx + \\ &+ \left| \int_{\Omega_{3\varepsilon+\delta}} [v(x, t+s) - v(x, t)] \beta_\varepsilon(x) \, dx \right| + \gamma(\Omega) \|v\|_\infty \varepsilon \leq 4\omega_\delta(\varepsilon) + \gamma \frac{s}{\varepsilon} + \gamma \varepsilon, \end{aligned}$$

where we used Lemma 1.2. Indeed, it is easily checked, with the help of (2.1) that

$$\int_{\Omega_\delta} \left| |v(x+h, t+s) - v(x+h, t)| - |v(x, t+s) - v(x, t)| \right| \, dx \leq 2\omega_\delta(|h|),$$

a.e. $0 < t < t+s < T$, and for δ and h as above.

The proof is concluded. \square

REMARK 2.1. It is clear that estimate (2.3) implies continuity in t of v in the $L^1(\Omega_\delta)$ norm. In the optimal case when $\omega_\delta(|h|) = C_\delta |h|$, on choosing $\varepsilon = \sqrt{s}$ (for $s < \delta^2$) we obtain

$$\int_{\Omega_\delta} |v(x, t+s) - v(x, t)| \, dx \leq \gamma \sqrt{s}. \quad (2.4)$$

APPENDIX C

The spaces $H^{m+\alpha, \frac{m+\alpha}{2}}(\overline{Q_T})$

We define here a class of Banach spaces of standard use in the regularity theory of parabolic equations (see [11]). Let $Q_T = \Omega \times (0, T)$, where $\Omega \subset \mathbf{R}^N$ is a bounded open set.

Fix the integer $m \geq 0$, and $\alpha \in (0, 1)$. In the following we denote with $D_t^r D_x^s u$, for $r, s \in \mathbf{N}$, any derivative of u , taken r times with respect to the time variable, and s times with respect to space variables. For a given function $u : Q_T \rightarrow \mathbf{R}$ we introduce the quantities

$$\begin{aligned} \langle u \rangle_{x, Q_T}^{(\alpha)} &= \sup_{(x, t), (x', t') \in Q_T} \frac{|u(x, t) - u(x', t')|}{|x - x'|^\alpha}, & \langle u \rangle_{x, Q_T}^{(m+\alpha)} &= \sum_{2r+s=m} \langle D_t^r D_x^s u \rangle_{x, Q_T}^{(\alpha)}, \\ \langle u \rangle_{t, Q_T}^{(\alpha/2)} &= \sup_{(x, t), (x, t') \in Q_T} \frac{|u(x, t) - u(x, t')|}{|t - t'|^{\alpha/2}}, \\ \langle u \rangle_{t, Q_T}^{\left(\frac{m+\alpha}{2}\right)} &= \sum_{2r+s=m-1, m} \langle D_t^r D_x^s u \rangle_{t, Q_T}^{\left(\frac{m+\alpha-2r-s}{2}\right)}. \end{aligned}$$

The sums above (and below) are extended to all the derivatives $D_t^r D_x^s u$ with r, s as indicated. If $m = 0$, the only such function is u itself.

Then we define the norm

$$\|u\|_{Q_T}^{(m+\alpha)} = \sum_{2r+s \leq m} \|D_t^r D_x^s u\|_{\infty, Q_T} + \langle u \rangle_{x, Q_T}^{(m+\alpha)} + \langle u \rangle_{t, Q_T}^{\left(\frac{m+\alpha}{2}\right)}.$$

The Banach space of the functions u whose norm $\|u\|_{Q_T}^{(m+\alpha)}$ is finite is denoted by

$$H^{m+\alpha, \frac{m+\alpha}{2}}(\overline{Q_T}).$$

1. Comments

The regularity ‘in time’ of $u \in H^{m+\alpha, \frac{m+\alpha}{2}}(\overline{Q_T})$ is ‘a half’ of the regularity ‘in space’, in a sense made precise by the definition itself. To illustrate this point, assume $s \in C([0, T])$, and regard s as a function defined over $\overline{Q_T}$. Let us make explicit the meaning of the statement

$$s \in H^{m+\alpha, \frac{m+\alpha}{2}}(\overline{Q_T}).$$

If m is even, $m = 2k$, this is equivalent to: $s \in C^k([0, T])$, and

$$\sup_{0 < t, t' < T} \frac{|s^{(k)}(t) - s^{(k)}(t')|}{|t - t'|^{\frac{\alpha}{2}}} < \infty.$$

If instead m is odd, $m = 2k - 1$, we have: $s \in C^{k-1}([0, T])$, and

$$\sup_{0 < t, t' < T} \frac{|s^{(k-1)}(t) - s^{(k-1)}(t')|}{|t - t'|^{\frac{1+\alpha}{2}}} < \infty.$$

Clearly, for all $m \geq 0$,

$$\dot{s} \in H^{m+\alpha, \frac{m+\alpha}{2}}(\overline{Q_T}) \implies s \in H^{2+m+\alpha, \frac{2+m+\alpha}{2}}(\overline{Q_T}). \quad (1.1)$$

APPENDIX D

Symbols used in text

$\ f\ _{p,D}$	norm of f in $L^p(D)$, $1 \leq p \leq \infty$; often the indication of the domain is omitted, when superfluous.
$\Omega(t)$	the set $\{(x, t) \mid x \in \Omega\}$.
$ \Omega $	the Lebesgue measure of the set Ω .
$\text{dist}(A, B)$	standard Euclidean distance between A and B .
$B_r(x)$	ball with center x and radius r .
$x \rightarrow s_0+$	x goes to s_0 from the right.
$x \rightarrow s_0-$	x goes to s_0 from the left.
$f(s_0+)$	denotes the limit of $f(x)$ as $x \rightarrow s_0+$.
$f(s_0-)$	denotes the limit of $f(x)$ as $x \rightarrow s_0-$.
s_+	positive part of $s \in \mathbf{R}$, $s_+ = \max(s, 0)$.
s_-	negative part of $s \in \mathbf{R}$, $s_- = \max(-s, 0)$.
δ_{ij}	Kronecker's symbol: $\delta_{ij} = 1$ if $i = j$, $\delta_{ij} = 0$ if $i \neq j$.
Df	spatial gradient of the function $f(x, t)$: $Df = (\frac{\partial f}{\partial x_1}, \dots, \frac{\partial f}{\partial x_N})$.
\mathbf{e}_k	k -th unit vector of the standard basis in \mathbf{R}^N .
$C(A)$	class of continuous functions in A . The same as $C^0(A)$.
$C^n(A)$	class of functions, continuous in A together with their derivatives up to order n .
$C_0^n(A)$	class of the functions in $C^n(A)$, whose support is compact and contained in A .
$C^{2,1}(A)$	class of functions f , such that f , $\frac{\partial f}{\partial t}$, $\frac{\partial f}{\partial x_i}$, and $\frac{\partial^2 f}{\partial x_i \partial x_j}$ are continuous in A for all $i, j = 1, \dots, N$.
$W_1^2(G)$	Sobolev space of functions in $L^2(G)$ whose first derivatives are in $L^2(G)$.
$W_{2,1}^2(G)$	Sobolev space of functions $f \in W_1^2(G)$ whose spatial derivatives $\frac{\partial^2 f}{\partial x_i \partial x_j}$ are in $L^2(G)$ for all $i, j = 1, \dots, N$.
PDE	Partial Differential Equation/Equations.

Bibliography

- [1] D. Andreucci. Behaviour of mushy regions under the action of a volumetric heat source. *Math. Methods in the Applied Sciences*, 16:35–47, 1993.
- [2] O. Arena. *Partial Differential Equations of Parabolic Type*. Notes of a course held at the University of Florence (Italy). Unpublished, 1983.
- [3] J. R. Cannon. *The One-Dimensional Heat Equation*, volume 23 of *Encyclopedia of Mathematics and Its Applications*. Addison-Wesley, Menlo Park, CA U.S.A., 1984.
- [4] E. DiBenedetto. Continuity of weak solutions to certain singular parabolic equations. *Ann. Mat. Pura Appl.*, 130:131–176, 1982.
- [5] A. Fasano. *Free Boundary problems and Their Applications*. Notes of a course held at SASIAM, Bari (Italy). 1989.
- [6] A. Fasano and M. Primicerio. New results on some classical parabolic free-boundary problems. *Quart. Appl. Math.*, 38:439–460, 1981.
- [7] A. Friedman. Remarks on the maximum principle for parabolic equations and its applications. *Pacific J. Math.*, 8:201–211, 1958.
- [8] I. G. Götz and B. B. Zaltzman. Nonincrease of mushy regions in a nonhomogeneous Stefan problem. *Quart. Appl. Math.*, 49:741–746, 1991.
- [9] S. L. Kamenomostskaya. On Stefan problem. *Mat. Sbornik*, 53:489–514, 1961. (In Russian).
- [10] S. N. Kruzhkov. First-order quasilinear equations in several independent variables. *Mat. Sb. (n.s.)*, 81:228–255, 1970. Engl. Transl.: *Math. USSR - Sb* 10 (1970), 217–234.
- [11] O. A. Ladyzhenskaja, V. A. Solonnikov, and N. N. Ural'ceva. *Linear and Quasilinear Equations of Parabolic Type*, volume 23 of *Translations of Mathematical Monographs*. American Mathematical Society, Providence, RI, 1968.
- [12] A. M. Meirmanov. *The Stefan Problem*, volume 3 of *de Gruyter Expositions in Mathematics*. Walter de Gruyter, Berlin, Germany, 1992.
- [13] L. Nirenberg. A strong maximum principle for parabolic equations. *Comm. Pure Appl. Math.*, 6:167–177, 1953.
- [14] O. A. Oleinik. A method of solution of the general Stefan problem. *Soviet Math. Dokl.*, 1:1350–1354, 1960.
- [15] M. Primicerio. Mushy regions in phase-change problems. In K. H. Hoffmann and R. Gorenflo, editors, *Applied Nonlinear Functional Analysis: Variational Methods and Ill-Posed Problems*, pages 251–269, Frankfurt, Germany, 1983. Verlag Peter Lang.
- [16] D. G. Schaeffer. A new proof of the infinite differentiability of the free boundary in the Stefan problem. *J. Diff. Equations*, 20:266–269, 1976.
- [17] J. Stefan. Über die Theorie der Eisbildung. *Monatshefte Mat. Phys.*, 1:1–6, 1890.
- [18] D. Tarzia. A bibliography on moving-free boundary problems for the heat-diffusion equation. The Stefan and related problems. *MAT-Serie A*, 2, 2000.
[http://www.austral.edu.ar/web/investigacion/2\(2000\).htm](http://www.austral.edu.ar/web/investigacion/2(2000).htm).
- [19] R. Viborni. On properties of solutions of some boundary value problems for equations of parabolic type. *Doklady Akad. Nauk SSSR (n.s.)*, 117:563–565, 1957. (In Russian).
- [20] A. Visintin. *Models of Phase Transition*, volume 28 of *Progress in Nonlinear Differential Equations and Their Applications*. Birkha user, Boston, MA U.S.A., 1996.